

# TITAN IMPLEMENT



## **2100 Series Gear Driven Tillers**

### **OPERATION AND PARTS MANUAL**

*Read and understand the manual. This manual provides information and procedures to safely operate and maintain the Rotary Tiller.*



January 2016



# Pre-Delivery Checklist

The Dealer should inform the Purchaser of this product of the Warranty terms, provisions, and procedures that are applicable. The Dealer and Purchaser should review the contents of the Operator's Manual including safety equipment, safe operation and maintenance, review the Safety Signs on the implement (and tractor if necessary), and the Purchaser's responsibility to train their operators in safe operation procedures.

- IMPLEMENTS: I have explained that Deflectors, Guards, or Shields must be installed and maintained in good repair.
- DRIVELINES: I have made certain that all driveline, gearbox, and other shields are in good repair and fastened securely in place to prevent injuries from entanglement or thrown objects.

## PRE-DELIVERY SERVICE CHECK AND ADJUST OR LUBRICATE AS REQUIRED

See Operator's Manual for Details

**Inspection Performed - Warranty and Safety Procedures Explained - Installation Complete**

### LUBRICATION & HYDRAULICS

- Gearbox and Gearcase Lubricant Level, Factory Filled

### TILLER

- Check that Gearbox Bolts are Properly Tightened
- Review Procedure to Adjust Tilling Depth
- Check that All Hardware is Properly Tightened
- Grease All Zerks

### ATTACHMENTS & INSTALLATION

- Make Sure all Guards and Shields are Attached
- Check that Tines are Installed in Correct Rotation Direction
- Make Sure All Bolts, Pins, and Nuts Are Properly Installed and Tightened

### TILLER TO TRACTOR CONNECTIONS

- Make Sure A-Frame Pivot & Links are Properly Installed
- Make Sure Lift Arms are Adjusted Equally
- Perform the Initial Setup Checklist and the Pre-Operation Checklist

### SAFETY ITEMS

- Make Sure Protective Shields are Properly Installed
- Make Sure Safety Decals are Installed
- Review Operator's Manual (Supplied)
- Make Sure Tractor PTO Shield is Installed
- Make Sure S.M.V. Sign is Installed if Needed (Customer Supplied)
- Review the supplied ADMA Driveline Safety Manual

I have thoroughly instructed the buyer on the above-described equipment. This review included the Operator's Manual content, equipment care, adjustments, safe operation, and applicable warranty policy.

Date \_\_\_\_\_

Dealer Rep. Signature \_\_\_\_\_

The above equipment and Operator's Manual have been received by me, and I have been thoroughly instructed as to care, adjustments, safe operation, and applicable warranty policy.

Date \_\_\_\_\_

Owner's Signature \_\_\_\_\_



# Table of Contents

<b>1. INTRODUCTION</b> .....	<b>6</b>	6.4 Attaching to Tractor .....	26
1.1 Welcome .....	6	6.5 Leveling the Rotary Tiller .....	27
1.2 Safe Operation .....	6	6.6 Detaching from Tractor .....	27
1.3 Safety Shields .....	6	6.7 Setting the Tilling Depth .....	27
1.4 Intended Usage .....	7	6.8 Initial Setup Checklist .....	28
1.5 Operator Orientation .....	7	6.9 Machine Break-In .....	29
1.6 Serial Number Location (Typical) .....	7	6.10 Pre-Operation Checklist .....	29
1.7 Product Improvements .....	7	6.11 Pre-Operation Site Inspection .....	29
1.8 Disposal of Equipment at End of Useful Life .....	7	6.12 Tiller Operation .....	30
1.9 Unanswered Questions .....	7	<b>7. TRANSPORTING</b> .....	<b>31</b>
<b>2. SAFETY</b> .....	<b>8</b>	7.1 Transporting Safety (Road) .....	31
2.1 General .....	8	<b>8. STORAGE</b> .....	<b>32</b>
2.2 Safety Alert Symbols .....	8	8.1 Storage Safety .....	32
2.3 Safety Icon Nomenclature .....	9	8.2 Placing in Storage .....	32
2.3.1 Personal Protection/Important Information .....	9	8.3 Removing from Storage .....	32
2.3.2 Prohibited Actions .....	9	<b>9. SERVICE AND MAINTENANCE</b> .....	<b>33</b>
2.3.3 Hazard Avoidance .....	9	9.1 Maintenance Safety .....	33
2.4 General Safety Instruction .....	10	9.2 Greasing .....	34
2.5 Training .....	11	9.3 Gearbox Lubrication .....	34
2.6 OSHA Training Requirements .....	11	9.4 Side Gearcase Lubrication .....	34
2.7 Federal Laws and Regulations .....	12	9.5 Driveline Lubrication .....	34
2.8 Sign-Off Form .....	13	9.6 Lifting .....	34
2.9 Operation .....	14	9.7 Tine Replacement .....	35
2.10 Transporting .....	14	9.8 Slip Clutch Adjustment .....	35
2.11 Storage .....	14	9.9 Slip Clutch Operational Check .....	35
2.12 Maintenance .....	14	9.10 Slip Clutch Disassembly/Assembly .....	36
<b>3. SAFETY SIGNS AND INSTRUCTIONAL LABELS</b> .....	<b>15</b>	9.11 Bolt Torque Requirements .....	36
3.1 General Information .....	15	9.12 Welding Repairs .....	36
3.2 How to Install Replacement Safety Signs .....	15	9.13 Service Record .....	37
3.3 Safety Sign Locations .....	16	<b>10. TROUBLESHOOTING</b> .....	<b>38</b>
3.3.1 Tiller Safety Signs .....	17	<b>11. SPECIFICATIONS</b> .....	<b>39</b>
<b>4. NOMENCLATURE</b> .....	<b>19</b>	11.1 Bolt Torque .....	40
<b>5. ASSEMBLY</b> .....	<b>20</b>	11.1.1 Standard Torque Values .....	40
5.1 Tools Required .....	20	<b>12. WARRANTY</b> .....	<b>41</b>
5.2 Assembly Procedure .....	20	<b>13. PARTS</b> .....	<b>45</b>
5.3 Installation and Removal of Driveline to Tractor PTO .....	22	13.1 Hitch Assembly .....	45
5.4 Checking the Driveline Length .....	22	13.2 Frame Assembly .....	46
5.5 Shortening the Driveline .....	23	13.3 Rear Deflector .....	47
5.6 Checking for Driveline Interference .....	23	13.4 Skid Shoes & Parking Stand .....	48
<b>6. OPERATION</b> .....	<b>24</b>	13.5 Rotor Shaft & Tines .....	49
6.1 Operating Safety .....	24	13.6 Driveline Assembly .....	50
6.2 User Safety Training .....	24	13.7 Gearbox .....	51
6.3 Tractor Requirements .....	25	13.8 Side Gearcase Detail .....	52
6.3.1 Tractor Requirements and Capabilities .....	25		
6.3.2 Tractor Safety Devices .....	25		
6.3.3 ROPS and Seat Belt .....	25		
6.3.4 3-Point Hitch .....	25		
6.3.5 Tractor Horsepower .....	26		
6.3.6 Power Take-Off (PTO) .....	26		

# 1. INTRODUCTION

## 1.1 Welcome



2100 Series Rotary Tiller

Congratulations on your choice of a Titan Implement rotary tiller. This equipment has been designed and manufactured to meet the needs of discerning users. The Titan Implement rotary tiller prepares the seed bed by breaking up clods, leveling soil, destroying weeds, and incorporating fertilizer.

Many features of this rotary tiller are the result of suggestions made by customers like you. Read this manual carefully to learn how to operate the rotary tiller safely and how to set it to provide maximum tilling efficiency.

By following the operating instructions in conjunction with a good maintenance program, your Titan Implement rotary tiller will provide many years of trouble-free service.

This manual covers Titan Implement rotary tiller models:			
Model	Model	Model	Model
2104	2105	2106	2107

## 1.2 Safe Operation

Safe, efficient, and trouble-free operation of your rotary tiller requires that you, and anyone else who will be using or maintaining the unit, read and understand the information contained within the Owner's Manual.

Use this manual for frequent reference and to pass on to new operators or owners.

### **WARNING**



Read And Understand Manual

**To prevent personal injury or even death, be sure you read and understand all of the instructions in this manual and other related OEM equipment manuals! The rotary tiller, if not used and maintained properly, can be dangerous to users unfamiliar with its operation. Do not allow operating, maintaining, adjusting, or cleaning of this rotary tiller until the user has read this manual and has developed a thorough understanding of the safety precautions and functions of the unit.**

**This rotary tiller is designed for the specific purpose of tilling soil in preparation for planting. DO NOT modify or use this rotary tiller for any application other than that for which it was designed.**

**Rotary tillers maintained or operated improperly or by untrained personnel can be dangerous; exposing the user and/or bystanders to possible serious injury or death.**

## 1.3 Safety Shields

Some of the illustrations in this manual may show the equipment with safety shields removed for clarity. Never operate the rotary tiller unless all safety shields are in place.

### **WARNING**



**Cutting or Entanglement Hazard**  
**Operating the rotary tiller without the safety shields can result in physical injury or death. Make sure all shields are properly installed before operating the rotary tiller. This equipment should never be operated with any safety shielding removed.**

## 1.4 Intended Usage

Do not use this rotary tiller for any other purpose than its intended use of tilling soil.

## 1.5 Operator Orientation

The directions left, right, front, and rear, as mentioned throughout this manual, are as seen from the tractor operator's seat and facing in the direction of travel.

## 1.6 Serial Number Location (Typical)

The serial number decal is located on top of the frame to the left of the A-frame.



Model Number \_\_\_\_\_

Serial Number \_\_\_\_\_

## 1.7 Product Improvements

Because Titan Implement, LLC maintains an ongoing program of product improvement, we reserve the right to make improvements in design or changes in specifications without incurring any obligation to install them on units previously sold.

## 1.8 Disposal of Equipment at End of Useful Life

The Titan Implement, LLC rotary tiller has been designed for the specific purpose of tilling soil. When this unit is no longer capable of doing its designed purpose, it should be dismantled and scrapped. Do not use any materials or components from this unit for any other purpose.

## 1.9 Unanswered Questions

If you have any questions not answered in this manual or require additional copies or the manual is damaged, please contact your dealer or:

Titan Implement, LLC  
P.O. Box 649  
232 Industrial Lane  
Decatur, TN 37322

Phone: (423) 334-0012

Fax: (423) 334-0023

## 2. Safety

### 2.1 General

Safety of the operator and bystanders is one of the main concerns in designing and developing a new piece of equipment. Designers and manufacturers build in as many safety features as possible. However, every year many accidents occur which could have been avoided by a few seconds of thought and a more careful approach to handling the equipment.

Most work-related accidents are caused by failure to observe basic safety rules or precautions. An accident can often be avoided by recognizing potentially hazardous situations before an accident occurs. As you assemble, operate, or maintain the rotary tiller (unit), you must be alert to potential hazards. You should also have the necessary training, skills, and tools to perform any assembly or maintenance procedures.

Improper operation and maintenance of this unit could result in a dangerous situation that could cause injury or death.

If you have any questions not answered in this manual or require additional copies or the manual is damaged, please contact your dealer or:

Titan Implement, LLC  
P.O. Box 649  
232 Industrial Lane  
Decatur, TN 37322  
Phone: (423) 334-0012  
Fax: (423) 334-0023

### **WARNING**



**Do not assemble, operate, or maintain the unit until you read and understand the information contained in this manual.**



**Safety precautions and warnings are provided in this manual and on the unit. If these hazard warnings are not heeded, bodily injury or death could occur to you or to other persons.**

Titan Implement, LLC cannot anticipate every possible circumstance that might involve a potential hazard. The warnings in this manual and on the unit are, therefore, not all-inclusive. If a method of assembly, operation, or maintenance not specifically recommended by us is used, you must satisfy yourself that it is safe for you and for others. You should also ensure that the unit will not be damaged or be made unsafe by the methods that you choose.

The information, specifications, and illustrations in this manual are based on the information that was available at the time this material was written and can change at any time without notice.

### 2.2 Safety Alert Symbols



This is the safety alert symbol and will be accompanied with a descriptive pictorial. It is used to alert you to potential personal injury hazards. Obey all safety messages that follow this symbol to avoid possible injury or death.

This manual contains DANGERS, SAFETY INSTRUCTIONS, CAUTIONS, IMPORTANT NOTICES, and NOTES which must be followed to prevent the possibility of improper service, damage to the equipment, personal injury, or death. The following key words call the readers' attention to potential hazards.

Hazards are identified by the "Safety Alert Symbol" and followed by a signal word such as "DANGER", "WARNING", or "CAUTION".

### **DANGER**

**Indicates an imminently hazardous situation which, if not avoided, will result in death or serious injury. This signal word is limited to the most extreme situations.**

### **WARNING**

**Indicates a potentially hazardous situation which, if not avoided, could result in death or serious injury.**

### **CAUTION**

**Indicates a potentially hazardous situation which, if not avoided, may result in minor or moderate injury.**

### **NOTICE**

*Indicates that equipment or property damage can result if instructions are not followed.*

### **SAFETY INSTRUCTIONS**

**Safety instructions (or equivalent) signs indicate specific safety-related instructions or procedures.**

**Note:** Contains additional information important to a procedure.





## 2.3 Safety Icon Nomenclature

Pictorial icons signal a type of hazard and warn of personal protection issues, prohibited actions, and hazard avoidance.

### 2.3.1 Personal Protection/ Important Information

-  Read the manual
-  Maintenance procedure
-  Damaged hazard label
-  Eye protection
-  Fire extinguisher
-  First aid kit
-  Hand protection
-  Head protection
-  Hearing protection
-  OEM parts only
-  Protective shoes
-  Remove key
-  Set parking brake
-  Stop engine
-  Transmission in park
-  Think safety
-  Use proper support
-  Use proper tools
-  Slow moving vehicle

-  Clear vision
-  Rollover protection
-  Weight rating

-  Maintain safe distance
-  Slipping injury
-  Tripping injury

### 2.3.2 Prohibited Actions

-  Do not alter or modify
-  Do not weld
-  No alcohol
-  No drugs
-  No smoking
-  No young children
-  No riders

### 2.3.3 Hazard Avoidance

-    Crush hazard
-  Crush hazard (foot)
-  Defective or broken part
-  Entanglement hazard
-  Falling hazard
-  Projectile hazard
-  Rollover protection
-  Rotating tines hazard
-  Safety alert symbol
-  Safety shields

## 2.4 General Safety Instruction

The owner/operator is responsible for the SAFE use and maintenance of the rotary tiller. Make sure anyone who is operating, maintaining, or working around the rotary tiller is familiar with the operating and maintenance procedures and related SAFETY information contained in this manual. This manual will take you step-by-step through your working day and alerts you to all good safety practices that should be used while using the rotary tiller.

In addition to the design features of the rotary tiller, including safety signs, accident prevention is dependent upon the awareness, concern, prudence, and proper training of the people involved in the operation, maintenance, and storage of the rotary tiller.

In addition to this safety section, refer also to safety messages and instructions in each of the appropriate sections of the rotary tiller manual.

These general safety instructions apply to the overall use and maintenance of the rotary tiller.

More specific instructions on safety are found in the operation, maintenance, and storage sections of this manual. Refer to these sections before performing any of these tasks.

### **WARNING**

**Failure to comply with the following safety instructions can and will result in serious injury and possibly even death if they are not understood and followed.**



#### Read and Understand Manual

**To prevent personal injury or even death, be sure you read and understand all of the instructions in this manual and other related OEM equipment manuals! The Titan Implement, LLC rotary tiller, if not used and maintained properly, can be dangerous to users unfamiliar with its operation. Do not allow operating, maintaining, adjusting, or cleaning of this rotary tiller until the user has read this manual and has developed a thorough understanding of the safety precautions and functions of the unit.**

**This rotary tiller is designed for the specific purpose of tilling soil in preparation for planting. DO NOT modify or use this rotary tiller for any application other than that for which it was designed.**

**Rotary tillers maintained or operated improperly, or by untrained personnel, can be dangerous; exposing the user and/or bystanders to possible serious injury or death.**

### **WARNING**



#### Provide User with Literature

**Titan Implement, LLC rotary tiller owners must provide operator instructions to anyone using the rotary tiller before use, and at least annually thereafter. Refer to “2.6 OSHA Training Requirements” on page 11.**



#### Stay Clear

**Clear the area of people, especially small children, before using the rotary tiller. Under no circumstances should young children be allowed to work with or around the rotary tiller.**



#### Impaired User Hazard

**Do not attempt to assemble, operate, or maintain this rotary tiller under the influence of drugs or alcohol. Consult your doctor before using this rotary tiller while taking prescription medications.**



#### Crush Hazard

**Do not allow anyone to ride on the tractor or the rotary tiller. Falling or crushing hazards can result in severe injuries or death.**



#### Falling Hazard

**Do not allow riders on the hitch, tractor, or rotary tiller at any time. Falling can result in severe injuries or death.**



#### No Unauthorized Modifications

**Do not modify the rotary tiller or safety devices. Do not weld on the unit. Unauthorized modifications may impair its function and safety. Personal injury or death can result from unauthorized modifications.**

**If the rotary tiller has been altered in any way from the original design, Titan Implement does not accept any liability for injury or warranty.**



#### Damaged Parts Hazard

**Do not use the rotary tiller if any parts are damaged. If the rotary tiller has a defect, immediately stop using it and remedy the problem before continuing.**



#### Rotating Tines Hazard

**To avoid serious injury or death, keep away from rotating tines. Do not put hands or feet under the rotary tiller deck.**

## WARNING

 Safety Shields  
Some illustrations in this manual may show the equipment with safety shields removed to provide a better view. This equipment should never be operated with any necessary safety shielding removed.

## CAUTION

The following safety instructions are provided to help prevent potential injury. Not following these instructions may lead to injury.

### Personal Protection Equipment

When using this rotary tiller, wear appropriate personal protective equipment. This list may include, but is not limited to:



- Protective shoes with slip resistant soles
- Protective goggles, glasses, or face shield
- Protective clothing and gloves
- Safety vest (when operating near roads)
- Hearing protection



### Ear Protection

Wear suitable ear protection during prolonged exposure to excessive noise.



### Hearing Loss

**Prolonged Exposure To Loud Noise May Cause Permanent Hearing Loss!**

Working environments with noise-producing equipment can cause partial to permanent hearing loss. We recommend using hearing protection any time noise levels exceed 80 decibels (dB). Noise levels over 85 dB, on a long-term basis, can cause severe hearing loss. Noise levels over 90 dB over a period of time can cause permanent and even total hearing loss.

Hearing loss from loud noise is cumulative over a lifetime without hope of natural recovery.



### Crush Hazard

The tractor should be equipped with a Roll Over Protective Structure (ROPS) and a seat belt. A crushing hazard can occur if the driver is ejected from the seat while the tractor is in motion. Fasten the seat belt whenever the tractor is moving.

## SAFETY INSTRUCTIONS

The following safety instructions are provided to help prevent injury or limit equipment damage.



### Safety Signs

Replace any missing or hard-to-read safety signs or instructional labels. Use care when washing or cleaning the rotary tiller.

Replacement safety sign locations and part numbers are provided in this manual and are available from an authorized dealer parts department or the factory.



### First Aid Kit

Have a first aid kit available for use should the need arise and know how to use it.



### Fire Extinguisher

Have a fire extinguisher available for use should the need arise and know how to use it.



### Think SAFETY!

Work SAFELY!

## 2.5 Training

Anyone who will be using and/or maintaining the rotary tiller must read, clearly understand, and follow ALL safety, operation, and maintenance information presented in this manual, other related OEM manuals, and the safety signs

If you do not understand any information in this manual, see your dealer or contact Titan Implement before proceeding.

Do not use or allow anyone else to use this rotary tiller until all information has been reviewed. Annually review this manual before the season start-up.

Make periodic reviews of SAFETY and OPERATION of the rotary tiller a standard practice. An untrained operator is not qualified to use this rotary tiller.

## 2.6 OSHA Training Requirements

The following training requirements have been taken from Title 29, Code of Federal Regulations Part 1928.57 (a) (6). [www.osha.gov](http://www.osha.gov).

Operator instructions. At the time of initial assignment and at least annually thereafter, the employer shall instruct every employee who operates an agricultural tractor and implements in the safe operating practices and servicing of equipment with which they are or will be involved, and of any other practices dictated by the work environment.

## 2.7 Federal Laws and Regulations

### IMPORTANT FEDERAL LAWS AND REGULATIONS CONCERNING EMPLOYERS, EMPLOYEES AND OPERATORS

This sections is intended to explain in broad terms the concept and effect of the following federal laws and regulations. It is not intended as a legal interpretation of the laws and should not be considered as such.

#### **U.S. PUBLIC LAW 91-596 (The Williams-Steiger Occupational Safety and Health Act of 1970) OSHA**

##### **This Act Seeks:**

“ ... to assure so far as possible every working man and woman in the nation safe and healthful working conditions and to preserve our human resources ... “

#### **DUTIES**

##### **Sec. 5(a) Each Employer -**

- (1) shall furnish to each of its employees employment and a place of employment which are free from recognized hazards that are causing or are likely to cause death or serious physical harm to its employees.
- (2) shall comply with occupational safety and health standards promulgated under this Act.
  - (b) Each employee shall comply with occupational safety and health standards and all rules, regulations, and orders issued pursuant to this Act which are applicable to his or her own actions and conduct.

##### **OSHA Regulations**

Current OSHA regulations state in part: “At the time of initial assignment and at least annually thereafter, the employer shall instruct every employee in the safe operation and servicing of all equipment with which the employee is, or will be involved.” These will include (but are not limited to) instructions to:

Keep all guards in place when the machine is in operation;

Permit no riders on equipment;

Stop engine, disconnect the power source, and wait for all machine movement to stop before servicing, adjusting, cleaning, or unclogging the equipment, except where the machine must be running to be properly serviced or maintained, in which case the employer shall instruct employees as to all steps and procedures which are necessary to safely service or maintain equipment.

Make sure no one is within 300 feet of machinery before starting the engine, engaging power, or operating the machine.

#### **EMPLOYEE TRACTOR OPERATING INSTRUCTIONS:**

1. Securely fasten your seat belt if the tractor has a ROPS.
2. Where possible, avoid operating the tractor near ditches, embankments, and holes.
3. Reduce speed when turning, crossing slopes, and on rough, slick, or muddy surfaces.
4. Stay off slopes too steep for safe operation.
5. Watch where you are going, especially at row ends, on roads, and around trees.
6. Do not permit others to ride.
7. Operate the tractor smoothly - no jerky turns, starts, or stops.
8. Hitch only to the drawbar and hitch points recommended by tractor manufacturers.
9. When tractor is stopped, set brakes securely and use park lock if available.

##### **Child Labor Under 16 Years Old**

Some regulations specify that no one under the age of 16 may operate power machinery. It is your responsibility to know what these regulations are in your own area or situation. (Refer to U.S. Dept. of Labor, Employment Standard Administration, Wage & Home Division, Child Labor Bulletin #102).

## 2.8 Sign-Off Form

Titan Implement, LLC follows the general Safety Standards specified by the Farm Equipment Manufacturers Association (FEMA), and the American National Standards Institute (ANSI). Anyone who will be using and/or maintaining the rotary tiller must read and clearly understand ALL safety, operation and maintenance information presented in this manual.

Do not use or allow anyone else to use this rotary tiller until all information has been reviewed. Annually review this manual before the season start-up. Make periodic reviews of SAFETY and OPERATION of the rotary tiller a standard practice. An untrained operator is not qualified to use this rotary tiller.

This sign-off sheet is provided for your recordkeeping to show that all personnel who will be working with the equipment have read and understand the information in this Operator's Manual and Parts Book and have been instructed in the operation of the equipment.

Sign-Off Form		
Date	User's Signature	Owner's Signature

## **2.9 Operation**

Refer to the Operation Section for safety recommendations related to operating the rotary tiller. All applicable safety recommendations in other sections should also be followed.

## **2.10 Transporting**

Refer to the Transporting Section for safety recommendations related to transporting the rotary tiller. All applicable safety recommendations in other sections should also be followed.

## **2.11 Storage**

Refer to the Storage Section for safety recommendations related to storing the rotary tiller. All applicable safety recommendations in other sections should also be followed.

## **2.12 Maintenance**

Refer to the Service and Maintenance Section for safety recommendations related to maintaining the rotary tiller. All applicable safety recommendations in other sections should also be followed.

### 3. SAFETY SIGNS AND INSTRUCTIONAL LABELS

#### 3.1 General Information

The types of safety signs (hazard labels) and instructional labels, along with their locations on the equipment, are shown in the following illustrations. Good safety practices require that you familiarize yourself with the various safety signs, the type of warning, and the area or particular operation related to that area that requires your SAFETY AWARENESS.



Think SAFETY!

Work SAFELY!

Pay close attention to the safety signs and instructional labels attached to the tractor and the rotary tiller. Duplicate safety signs, which are attached to the rotary tiller, can also be found in this section. If the rotary tiller is missing a label or one is unreadable, replace the label before using the rotary tiller.

#### SAFETY INSTRUCTIONS



#### Safety Signs and Instructional Labels

1. **Keep safety signs or instructional labels clean and legible at all times. Use a clean, damp cloth to clean safety decals.**
2. **Replace any missing or hard-to-read safety signs or instructional labels.**
3. **Use care when washing or cleaning the equipment not to remove or damage the labels. When using a pressure washer to clean the rotary tiller, avoid spraying too close to decals; high-pressure water can enter through very small scratches or under edges of decals causing them to peel or come off.**
4. **Locations for the labels and replacement part numbers are shown in this section.**
5. **Replacement parts must have replacement labels attached during installation and/or before the rotary tiller is used.**
6. **Labels are available from your authorized dealer or from Titan Implement at no charge.**

#### 3.2 How to Install Replacement Safety Signs

1. Clean and dry the installation area.

**Note:** Do not install the signs if the temperature is below 50°F (10°C).

2. Determine the exact position before you remove the backing paper.
3. Remove the backing paper.
4. Align the sign over the specified area and carefully press the sign to the part/frame.

**Note:** Small air pockets can be pierced with a pin and smoothed out using the piece of backing paper.

### 3.3 Safety Sign Locations

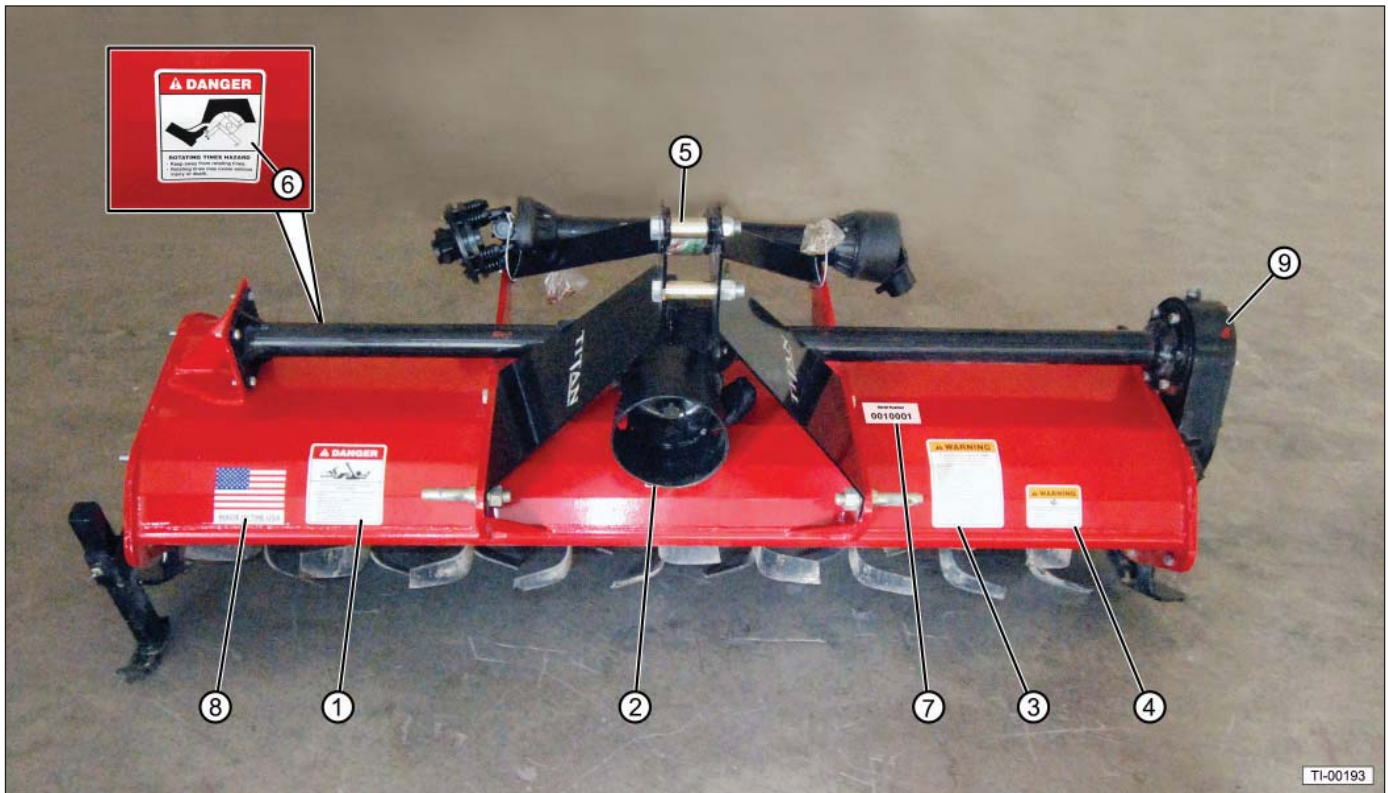

Safety Sign Locations.

Item	Type	Description	Qty.
1	DANGER	Driveline Hazard	1
2	DANGER	Guard Missing, Do Not Operate	1
3	WARNING	Multi-Hazard	1
4	WARNING	Keep Clear	1
5	DANGER	Rotating Driveline, Keep Away, Outer Shield Tube	1
6	DANGER	Rotating Tines Hazard, Rear Deflector	1
7	SERIAL	Serial No.	1
8	INSTRUCTIONAL	Made In the USA	1
9	INSTRUCTIONAL	Gear Driven	1



### 3.3.1 Tiller Safety Signs

1. 

2. 

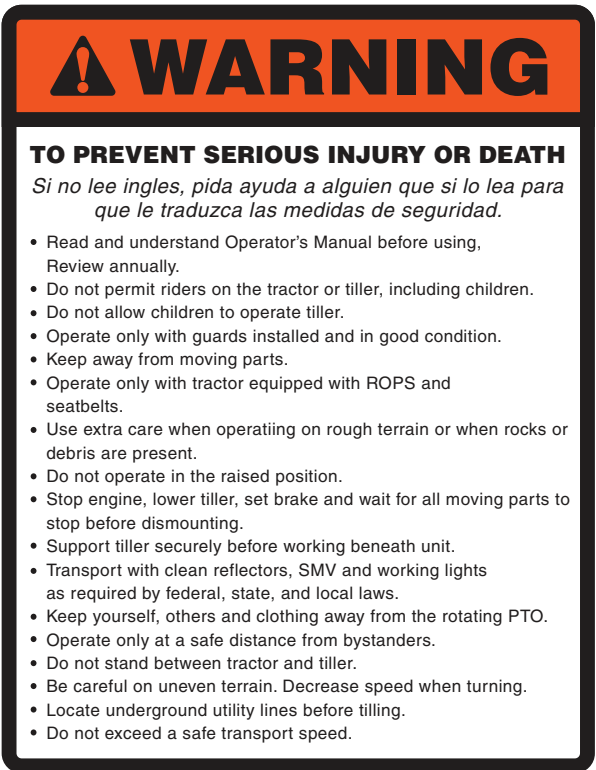
3. 

4. 

5. 



6.



7.

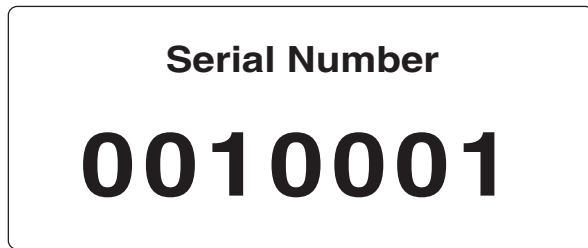

8.



9.



## 4. Nomenclature

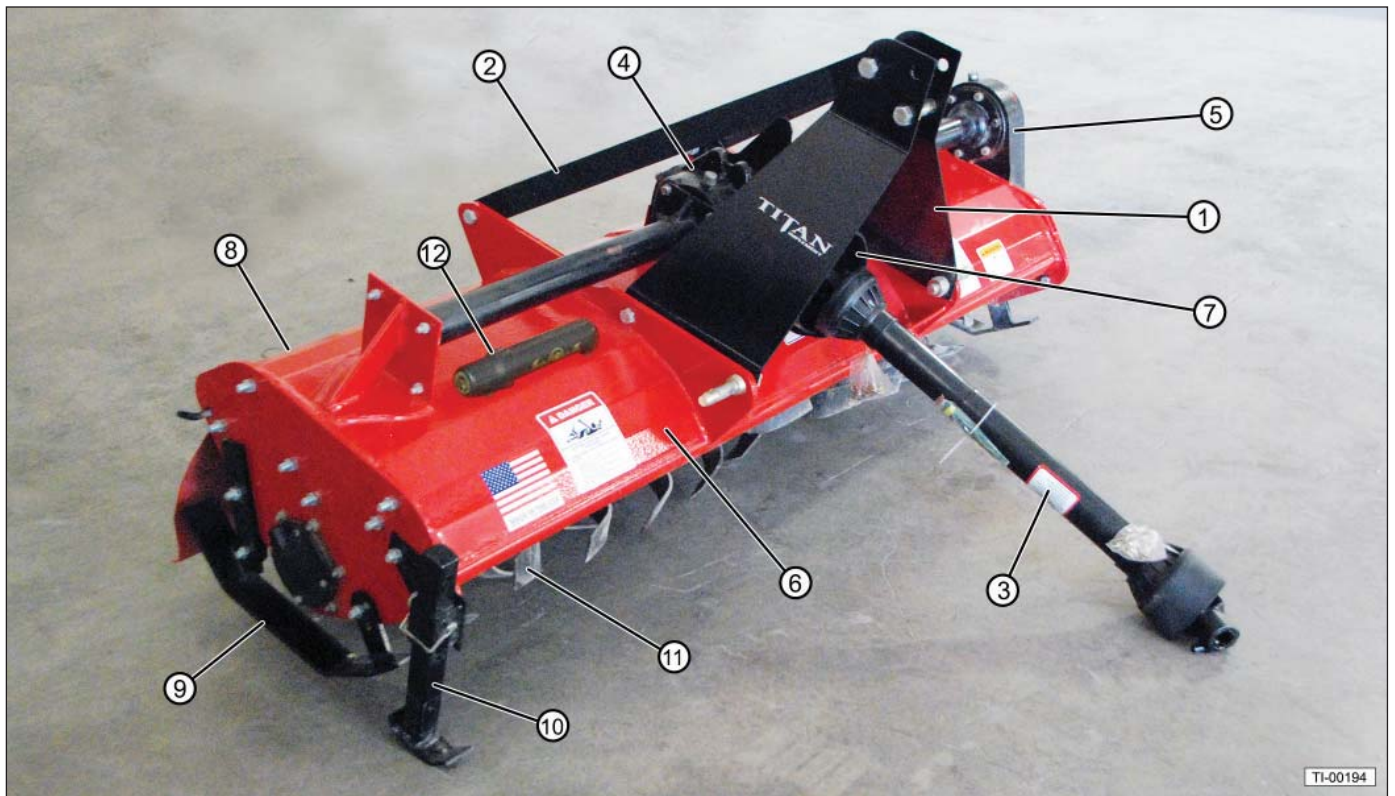

Item	Description	Qty.
1	A-Frame	1
2	Back Braces	2
3	Driveline	1
4	Gearbox	2
5	Gear Drive	1
6	Tiller Frame	1
7	Driveline Shield	1
8	Rear Deflector	1
9	Adjustable Skid Shoe	2
10	Parking Stand	1
11	Rotor Assembly	1
12	Document Holder	1

## 5. Assembly

### 5.1 Tools Required

Tools Required
Wire Cutter
Wrench, 3/4"

### 5.2 Assembly Procedure

1. Verify that all parts shown are included and are undamaged. If any parts are missing or damaged, contact your Titan Implement dealer.



2. Cut the wires holding the driveline to the back braces.



3. Separate the two halves of the driveline.



4. Remove the retaining bolt from the slip clutch.



5. Line up the spline grooves and slide the slip clutch onto the gearbox input shaft until the retaining bolt hole aligns with the groove in the shaft.



6. Install the retaining bolt through the access hole in the driveline shield, and tighten the locknut.



9. Apply a bead of grease around the end of the inner drive shaft.



7. Close the access covers on the gearbox shield.



10. Slide the front driveline half over the rear half. Align the square rib on the mating halves to engage.

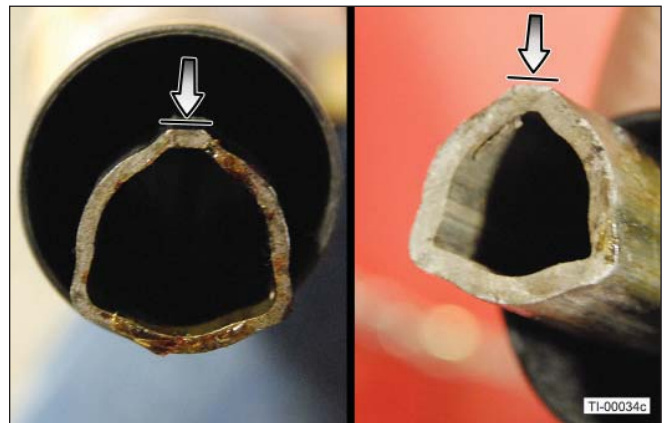

8. Attach the chain on the outer shield to the rotary tiller.



11. Apply grease to the zerk on the U-joint cross.

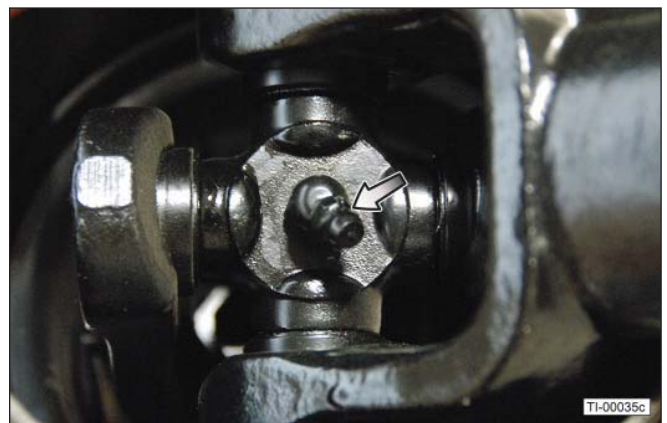

## **WARNING**



Crush Hazard

If the retaining bolt is not present, the driveline may separate from the gearbox, causing serious injury or death. Do not omit the retaining bolt. Tighten the locknut securely.

### 5.3 Installation and Removal of Driveline to Tractor PTO

#### **WARNING**



Entanglement Hazard

To avoid serious injury or death from driveline contact:

Shut off tractor PTO and disengage before dismounting.

Do not operate PTO if shields are missing or damaged.

Keep hands, feet, and body away from rotating parts.

To install the driveline:

1. Turn the tractor off, set the parking brake, and remove the key.
2. Depress the locking pin on the tractor end of the driveline.



3. Push the driveline onto the tractor PTO shaft until the locking pin engages.



4. Attach the safety chain on the driveline guard to the tractor.

To remove the driveline:

1. Turn the tractor off, set the parking brake, and remove the key.
2. Detach the safety chain on the driveline guard from the tractor.
3. Depress the locking pin on the tractor end of the driveline.
4. Slide the driveline off the tractor PTO shaft.

### 5.4 Checking the Driveline Length

Before operating the rotary tiller, make sure the driveline will not bottom out (too long) or become disengaged (too short). Bottoming out occurs when the inner shaft penetrates the outer housing until the assembly can shorten no more. Bottoming out can cause serious damage to the tractor PTO by pushing the PTO into the tractor and through the support bearings or downward onto the PTO shaft, breaking it off. A broken driveline can cause personal injury.

**There must be at least six inches of engagement at the longest possible point of operation.** If the driveline is too short, call your Titan Implement dealer for a longer driveline. If the driveline is too long, follow the instructions for shortening the driveline.

1. Attach the rotary tiller to the tractor's 3-point hitch. Do not attach the driveline. Keep the driveline out of the way of moving parts.
2. Position the rotary tiller to align the tractor PTO shaft level with the gearbox input shaft. This is the shortest distance between the two shafts. Securely block the tiller at this height to keep it from lowering while attaching the driveline.

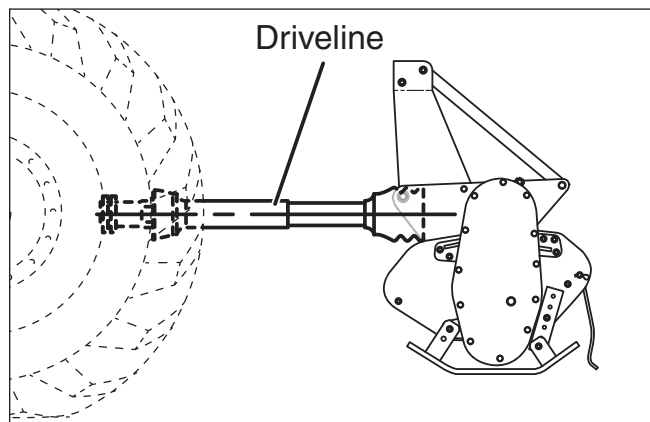

3. Turn the tractor off, set the parking brake, and remove the key.
4. Separate the driveline into two halves and connect them to the tractor PTO and gearbox.

5. Place the driveline halves parallel to one another to determine the need to shorten the driveline.
6. Each section should end approximately 3" short of reaching the universal joint shield on the opposite section. If too long, measure 3" back from the universal joint shield and mark on the opposite section. **Do not cut at this time.**
7. Repeat Step 6 for the other half of the drive.
8. Start the tractor and raise the rotary tiller just enough to remove the support blocks from under it.
9. Raise and lower the rotary tiller to determine the greatest distance between PTO shaft and gearbox input shaft. Shut down tractor leaving rotary tiller in position of greatest distance. Securely block rotary tiller in position.
10. Hold driveline sections parallel to each other and check for minimum 6" overlap. If the driveline has been marked for cutting in Step 6, the overlap will be the distance between the marks. If the driveline has less than minimum overlap, do not use it. Contact your Titan Implement dealer.

**Note:** If driveline is the correct length, omit the following Section.

## 5.5 Shortening the Driveline

1. Clamp a driveline section in a well padded vice to prevent damage to the shield. Cut off the shield where previously marked. Using the cut off section of the shield as a guide, cut the shaft the same amount. Repeat for the other driveline section.
2. File and clean the cut ends of both drive halves. Remove all chips and filings.
3. Apply multi-purpose grease around the inner driveline section. Slide drive halves over each other several times to distribute the grease. Install the driveline on tractor and rotary tiller. Make certain the driveline shield is in place and in good condition.

**Note:** Do not use the rotary tiller if proper driveline engagement cannot be obtained through these methods. Contact your Titan Implement dealer.

## 5.6 Checking for Driveline Interference

1. Start the tractor and raise the rotary tiller just enough to remove the support blocks from under it.
2. Slowly engage the tractor hydraulic 3-point control lever and lower tiller while checking for sufficient drawbar clearance. Move the drawbar ahead, aside, or remove if required.
3. With PTO off, raise the tiller fully and make sure that:
  - Tines are not more than 14" off the ground.
  - Driveline angle does not exceed 25° up.
  - Driveline has at least 6" of overlap.
4. If necessary, set the tractor 3-point lift control to keep the driveline within these limits.

### **WARNING**



Crush Hazard  
**Exceeding an angle of 25 degrees up or down with driveline rotating can break the driveline, causing serious injury or death.**  
**Do not exceed an angle of 25 degrees up or down while operating.**

## 6. Operation

### 6.1 Operating Safety

#### **WARNING**



#### Crush Hazard

The tractor should be equipped with a Roll Over Protective Structure (ROPS) and a seat belt. A crushing hazard can occur if the driver is ejected from the seat while the tractor is in motion. Fasten the seat belt whenever the tractor is moving.



#### Stay Clear

Clear the work area of all unnecessary people and obstructions to prevent personal injury.



#### Rotating Tines Hazard

To avoid serious injury or death, keep away from rotating tines. Do not put hands or feet under rotary tiller frame.

Do not operate under trees with low hanging limbs or other overhead obstacles. You can be knocked off the tractor and then run over by the rotating tines.



#### Entanglement Hazard

To avoid serious injury or death from driveline contact:

Shut off tractor PTO and disengage before dismounting.

Do not operate PTO if shields are missing or damaged.

Keep hands, feet, and body away from rotating parts.



#### Projectile Hazard

The tiller can discharge objects at high speeds. To avoid serious injury or death, always disengage the PTO before lifting the tiller up and never operate the tiller in the raised position.



#### Crush Hazard

A loose driveline that slips off the end of a connected shaft while rotating can cause serious bodily injury or death. Always make certain the driveline is secured to the tractor PTO shaft and gearbox input shaft before engaging the PTO.



#### Entanglement Hazard

Objects such as wire, cable, rope, or chains, can become entangled in the operating parts of the tiller. These items could then swing outside the housing at greater velocities than the tines, and cause serious bodily injury or death. Inspect the area to be tilled and remove any such objects before tilling.

#### **WARNING**



#### Roll Away Hazard

Before leaving the tractor seat, make sure the engine is stopped, the transmission is placed in park, the key is removed, and the parking brake is set.



The weight of the tractor, plus the rotary tiller if it rolls onto a person, can cause serious crushing injury or death.

### 6.2 User Safety Training

Refer to “2.5 Training” on page 11 for user safety training requirements.

#### **SAFETY INSTRUCTIONS**

The following safety instructions are provided to help prevent injury or limit equipment damage.



#### Train Unfamiliar Users

It is the rotary tiller owner's responsibility to make sure any person using the rotary tiller, especially if it is loaned or rented, has been thoroughly trained on its proper and safe use.

Train all new users and review instructions annually with existing users.

Be certain only physically able persons will use the rotary tiller.

Users who have not read and understood all operating and safety instructions are not qualified to use the rotary tiller.

Untrained users expose themselves and bystanders to possible serious injury or death.

If the elderly are assisting with the work, their physical limitations need to be recognized and accommodated.

Never allow children to operate equipment.



## 6.3 Tractor Requirements



### **⚠ WARNING**



Tractor Owner/Operator Manual  
**Always refer to the tractor owner's manual to ensure compatibility and maximum safety.**

The tractor used to operate the tiller must have the power capacity to lift, pull, and operate the Power Take Off (PTO) at 540 RPM while traveling at a ground speed up to 3 MPH.

The tractor must be matched to the weight of the rotary tiller. A minimum of 20% of the combined tractor and equipment weight should be on the front wheels. This will ensure adequate stability during transport and operation.

Operating the tiller with a tractor that does not meet the following requirements may cause tractor or tiller damage and be a potential danger to the operator and passersby.

Always review the "controls" section of the tractor operator's manual to be familiar with the location, settings, and function of the tractor controls. Be familiar with all controls before using this equipment.

### 6.3.1 Tractor Requirements and Capabilities

- Approved Roll-Over Protective Structure (ROPS) or ROPS cab and seat belt.
- Tractor Safety Devices; Slow Moving Vehicle (SMV) emblem, lighting, PTO master shield
- 3-Point Hitch, CAT I/II/QH
- Front End Weight as needed to maintain 20% weight on front axle.

## 6.3.2 Tractor Safety Devices

If transporting or operating the tractor and implement near a public roadway, the tractor must be equipped with proper warning lighting and a Slow Moving Vehicle (SMV) emblem which are clearly visible from the rear of the unit. Lights and a SMV emblem must be equipped directly on implements if the visibility of the tractor warning signals are obscured.

Maintain all manufacturer equipped safety shields and guards. Always replace shields and guards that were removed for access to connect, service, or repair the tractor or implement. Never operate the tractor PTO with the PTO master shield missing or in the raised position.

### 6.3.3 ROPS and Seat Belt

### **⚠ WARNING**



Rollover Hazard

**To avoid serious injury or death from falling off tractor, equipment runover, rollover, or crushing:**

- 1) Use ROPS equipped tractor.
- 2) Keep ROPS locked in the UP position.
- 3) Only operate the equipment when seated in the tractor seat.
- 4) Always fasten seat belt when operating the tractor and rotary tiller.

The tractor must be equipped with a Roll Over Protective Structure (ROPS) (tractor cab or roll bar) and seat belt to protect the operator from falling off the tractor, especially during a roll-over where the driver could be crushed and killed. Only operate the tractor with the ROPS in the raised position and seat belt fastened.

Tractor models not equipped with a ROPS and seat belt should have these life saving features installed by an authorized dealer.

### 6.3.4 3-Point Hitch

These rotary tillers are designed to be mounted on a tractor CAT I 3-Point or Quick Hitch. The 2107 is also available with CAT II hitch pins.

Refer to the tractor operator's manual for the category of the tractor being used. If the hitch does not conform to ASABE CAT I dimensions, the rotary tiller may not fit or raise properly. Consult an authorized dealer for possible modification procedures to mount non-conforming hitches. Depending on the hitch category, certain size pins are used to attach the rotary tiller to the tractor. CAT I hitches require 7/8" lower and 3/4" upper diameter hitch pins. CAT II hitches require 1-1/8" lower and 1" upper diameter hitch pins.

### 6.3.5 Tractor Horsepower

The power required to operate the tiller is determined by the tractor PTO horsepower. Operating the tiller with a tractor that does not have adequate power may damage the tractor engine. Exceeding recommended HP may cause rotary tiller damage by overpowering the unit in heavy cutting conditions.

Model	Recommended HP	Lifting Capacity (Min.)
2104	20-35	600
2105	20-40	690
2106	30-50	780
2107	45-65	865

### 6.3.6 Power Take-Off (PTO)

This rotary tiller is designed to operate at a PTO speed of 540 RPM. Most tractors operate at either 540 or a combination of 540 and 1000 RPM PTO speeds. The operating speed of the rotary tiller and tractor can be determined by the number of splines on the driveline yoke and PTO output shaft. Those operating at 540 RPM will have a 6-spline shaft, and those operating at 1000 RPM will have a 21-spline shaft.

**Note:** The rotary tiller will not operate on tractors equipped with a 1000 RPM 21-spline or 1000 RPM 20-spline, 1-3/4" shaft.

Refer to the tractor owner's manual for instructions to change PTO speeds on models that operate at more than one speed.

If operating an older model tractor where the tractor's transmission and PTO utilize one master clutch, an over-running clutch must be used between the PTO output shaft and the driveline of the rotary tiller. An authorized tractor dealer can provide the over-running clutch and its installation, if needed.

DO NOT use a PTO adapter to attach a non-matching implement driveline to a tractor PTO. Use of an adapter can double the operating speed of the implement, resulting in excessive vibration, thrown objects, and blade and implement failure. Adapter use will also change the working length of the driveline exposing unshielded driveline areas. Serious bodily injury and/or equipment failure can result from using a PTO adapter. Consult an authorized dealer for assistance if the implement driveline does not match the Tractor PTO.

### 6.4 Attaching to Tractor

Use caution when connecting the rotary tiller to the tractor. The rotary tiller should be securely resting at ground level or setting on blocks. Keep hands and feet from under the frame and clear of pinch points between the tractor hitch arms and rotary tiller hitch pins.

## WARNING



Crush Hazard

**Crush hazard between hitch and implement. Do not allow anyone to stand between the hitch and implement during hook-up operations. Never operate the hydraulic 3-point lift controls while someone is directly behind the tractor.**

1. Shorten or remove the tractor drawbar to avoid interference when raising and lowering the rotary tiller.
2. Board the tractor and start the engine. Position the tractor with the 3-point lift arms positioned at the same height and to the outside of the rotary tiller hitch pins.  
**Note:** Set the 3-point lift control to "Position Control" so that the lift arms maintain a constant height when attaching the rotary tiller. See the tractor Operator's Manual for correct settings when attaching 3-point equipment.
3. Turn off the tractor engine, remove the key, and set the parking brake.
4. One lift arm at a time, insert hitch pin through the lift arm holes and install retaining pin.
5. Extend or retract 3-point top link to align its end hole with the holes of the rotary tiller's top link. Insert the top link hitch pin and insert the retaining pin into the hitch pin.
6. Adjust any lower link check chains, guide blocks, or sway blocks to prevent the rotary tiller from swaying side-to-side and to prevent possible contact with the tractor rear tires.
7. Depress the locking pin on the tractor end of the driveline and push the driveline onto the tractor PTO shaft until the locking pin engages.
8. Remove the locking pin on the parking stand, raise it, and re-install the locking pin.
9. The PTO shaft shield must be secured prior to use. Attach the chain on each yoke shield to a fixed object on the tractor and equipment ends so that the PTO shaft shield cannot rotate during operation.

## 6.5 Leveling the Rotary Tiller

1. Move the rotary tiller to a level storage location and lower it to a height of 1" off the ground. Park the tractor, place the transmission in park or neutral, and apply the parking brake. Shut down the engine, remove the key, and wait for all motion to come to a complete stop before exiting the tractor.
2. Check to see if the top of the tiller deck is parallel to the ground.
3. If necessary, level the rotary tiller side-to-side by manipulating one lower lift arm length. On most tractors, at least one of the lift arms is designed to allow for manipulation of its length. Shortening or extending the lift arm will allow for frame leveling from side-to-side.
4. If necessary, level the rotary tiller front-to-back by extending or shortening the tractor's 3-point hitch top link as needed. Extend the link to raise the front of the tiller, shorten the link to lower the front of the tiller.

## 6.6 Detaching from Tractor

1. Move the rotary tiller to a level storage location and lower it to the ground or onto blocks. Park the tractor, place the transmission in park or neutral, and apply the parking brake. Shut down the engine, remove the key, and wait for all motion to come to a complete stop before exiting the tractor. Before disconnecting the rotary tiller, the PTO must be disengaged and tine rotation at a complete stop.
2. Make sure the rotary tiller is resting securely on the ground or blocks and set the parking stand. Install the locking clip. Use extreme care to keep feet and hands from under the rotary tiller and clear of any pinch points caused by the tractor hitch arms and rotary tiller hitch pins.
3. Extend the tractor 3-point hitch top link to remove tension on the top link hitch pin. When the pin is loose and easy to rotate, remove the pin from the rotary tiller.
4. Disconnect the lift arms and remove the rotary tiller driveline from the tractor PTO shaft. Lay the driveline down carefully to avoid damaging the driveline or its shield. Do not let the driveline fall into mud or dirt, which can contaminate the bearing and shorten the life of the driveline.

## 6.7 Setting the Tilling Depth

Tilling depth is the vertical distance from the bottom of the skid shoes to the bottom of the lowest tine. The skid shoes can be raised or lowered for the desired tilling depth. Make sure both skid shoes are adjusted the same.

1. Raise the tiller off the ground and properly support it.
2. Loosen pivot bolts (1) and (2) on the skid shoe.

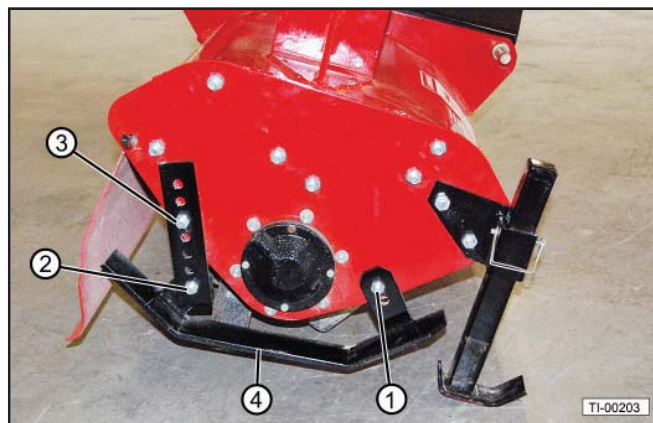

3. Remove adjusting bolt (3) on rear of shoe.
4. Adjust skid shoe (4) to desired location.
5. Reinstall adjusting bolt.

**NOTE:** Pivot bolt (1) may need to be moved to the alternate hole to keep the tiller level.

6. Tighten the pivot bolts.
7. Repeat for the other skid shoe.





### NOTICE





*Do not operate the rotary tiller without the skid shoes in place.*

## 6.8 Initial Setup Checklist

Efficient and safe operation of the rotary tiller requires that every user read and understand the operational instructions and all related safety instructions outlined in this manual.

This Initial Setup Checklist is provided for the user/owner. It is important for both personal safety and to maintain the mechanical condition of the rotary tiller that this checklist is followed.

Initial Setup Checklist (prior to using for the first time)		
✓	Location	Task
		Verify all safety signs are in place and legible. Refer to "3.3 Safety Sign Locations" on page 16.
		Make sure the rotary tiller is properly mounted to the 3-point hitch. Refer to "6.4 Attaching to Tractor" on page 26.
		Make sure the driveline is attached to the tractor PTO. Refer to "5.3 Installation and Removal of Driveline to Tractor PTO" on page 22.
		Make sure all hardware is properly installed and tightened. Refer to "11.1 Bolt Torque" on page 40.
		Check for worn, bent, broken, loose and/or missing tines. Replace tines as needed. Refer to "9.7 Tine Replacement" on page 35.

Initial Setup Checklist (prior to using for the first time)		
✓	Location	Task
	 	Lubricate all grease zerks and driveline slip joint. Refer to "9.2 Greasing" on page 34.
		Make sure all safety shields and guards are properly installed. Refer to "5. Assembly" on page 20.
		Check the tilling depth. Adjust if needed. Refer to "6.7 Setting the Tilling Depth" on page 27.

## 6.9 Machine Break-In

Although there are no operational restrictions on the rotary tiller when used for the first time, it is recommended that the slip clutch operational check be performed before the first use.

Driveline components are protected from shock loads by the friction slip clutch. The clutch must be capable of slippage during operation to protect the gearbox, driveline, and other drive train parts.

The operational check should be repeated after long periods of inactivity and whenever moisture and/or condensation seizes the inner friction plates. To remove any oxidation that may have accumulated on the friction surfaces, perform the Slip Clutch Operational Check procedure at the beginning of each season. Refer to "9.9 Slip Clutch Operational Check" on page 35.

1. Before using for the first time.
  - a. Lubricate all grease fittings.
  - b. Perform the slip clutch operational check. Refer to "9.9 Slip Clutch Operational Check" on page 35.
2. After 1/2 hour of operation:
  - a. Tighten all fasteners if necessary.
  - b. Lubricate all grease fittings.
3. After 10 hours of operation:
  - a. Go to the normal servicing and maintenance schedule, as defined in the Maintenance Section.
4. At the beginning of each season:
  - a. Perform the Slip Clutch Operational Check procedure.

## 6.10 Pre-Operation Checklist

Before each use of the rotary tiller, the following areas should be checked.

Checklist Before Each Use	
✓	Task
	Make sure the rotary tiller is positively attached to the tractor 3-point hitch. Refer to "6.4 Attaching to Tractor" on page 26
	Use only an appropriately sized tractor to pull the rotary tiller. Refer to "6.3 Tractor Requirements" on page 25.
	Make sure the driveline is properly attached to the tractor PTO. Refer to "5.3 Installation and Removal of Driveline to Tractor PTO" on page 22
	Make sure all safety shields and guards are properly installed.
	Check the condition of the tines.
	Check the tilling depth. Adjust if needed. Refer to "6.7 Setting the Tilling Depth" on page 27.
	Inspect the overall rotary tiller for potential problems or damage. Do not use the rotary tiller if it needs repairs of any type.

## 6.11 Pre-Operation Site Inspection

Although the rotary tiller is easy to use, each operator should review this section to familiarize themselves with the detailed safety and operating procedures. When using this machine, follow this procedure:

1. Clear the area of bystanders, especially small children.
2. Clear the area to be tilled of large limbs, rocks, trash, metal, wire, cable, rope, chains, extraneous debris, and any hard objects.
3. Mark the location of objects that cannot be removed.
4. Operate the rotary tiller only in conditions where you have clear visibility in daylight or with adequate artificial lighting. Make sure that you can clearly see and identify bystanders, steep slopes, ditches, drop-offs, overhead obstructions, debris, and foreign objects. If you are unable to clearly see these type of items, discontinue operating the tiller.
5. Never operate the rotary tiller in an area that you have not inspected and removed debris or foreign material.
6. Never operate the rotary tiller over any underground wiring, pipes, or other obstructions. If unsure, contact your local utility services so that they may mark the location of all underground utilities in the area.

## 6.12 Tiller Operation

1. Review and follow the Pre-Operation Checklist.
2. Carefully drive the tractor to the site to be tilled.
3. Make sure the site has been cleared of any large limbs, rocks, trash, metal, wire, cable, rope, chains, extraneous debris, and any hard objects.
4. Lower the tiller half way to the ground and reduce the tractor engine speed to about one quarter throttle.
5. Engage the PTO and gradually increase the engine speed to full PTO speed of 540 rpm.
6. Lower the tiller to the ground and simultaneously commence forward travel.

### **NOTICE**

*Do not turn or back up when the tines are in the ground. Damage to the tiller will result.*

---

7. Travel about 50 ft. and then stop to check the results. When stopping, lift the tiller out of the ground, stop the tractor, reduce engine speed, disengage the PTO, set the parking brake, shut off the tractor, and remove the keys.
8. If the depth is too shallow or too deep, adjust the skid shoes accordingly. If the soil texture is too coarse, reduce the ground speed. If the soil texture is too fine, increase the ground speed.

Average soil with reasonable moisture will allow travel speeds up to 2 mph. Hard soil will require low travel speed, less than 1 mph, to ensure smooth operation and maximum possible depth. Shallow weed cultivation will allow speeds up to 3 mph. The rotation of the tines will tend to propel the tiller forward. Always use the tractor transmission to control the travel speed.

**Do not make turns or attempt to back up while the tiller is in the ground.**

9. At the end of a pass, lift the tiller clear of the ground before turning.
10. After turning, proceed back across the field, slowly lowering the tiller into the soil. Do not turn with the tiller in the ground as this can damage the tiller and tractor linkage.
11. Stay alert and watch for trees, low hanging limbs, power lines, and other overhead obstacles while you are operating. Use care to avoid hitting these items.

12. Never use reverse gear while the tiller is lowered into the ground. Avoid operating the tiller in the raised position.
13. Periodically check for foreign objects wrapped around the rotor shaft and remove them after disengaging the PTO, turning off the engine, and removing the ignition key.
14. When finished tilling for the day, make sure to use the proper tractor shut down procedures before dismounting the tractor.
15. After each use clean all debris from the tiller tines.
16. If detaching the tiller, make sure to park it on a dry and level surface, leaving it clean and ready for the next use.

When placing the tiller in storage, refer to "8. Storage" on page 32.

For any other problem conditions that may arise, refer to "10. Troubleshooting" on page 38.

## 7. Transporting

### 7.1 Transporting Safety (Road)

#### **WARNING**



Failure to comply with the following safety instructions can and will result in serious injury and possibly even death.

 **Tractor Owner/Operator Manual**  
Always refer to the tractor owner's manual to determine its compatibility and maximum safety.



 **Operating the Tractor**  
Before attaching the rotary tiller to the tractor, be familiar with its controls and how to stop it quickly in the event of an emergency. Read and understand this manual and the one provided with your tractor before transporting the rotary tiller.

 **Fall and Crush Hazard**  
Do not allow riders on the rotary tiller or tractor.

 **Maximum Transporting Speed**  
Do not exceed 20 MPH (33 kph) when transporting the rotary tiller. Slow down for corners and rough terrain.

  **Visibility**  
Clean reflectors, SMV or SIS sign, and lights before transporting. Make sure all the lights and reflectors required by highway and transport authorities are in place and can be seen clearly by all overtaking and oncoming traffic.

 **Regulations**  
Make sure all local, state, and federal regulations, regarding the transport of equipment on public roads and highways, are met. Check with the local authorities regarding transporting the rotary tiller on public roads. Obey all applicable laws and regulations.

  **Rollover Protection**  
The tractor should be equipped with a Roll Over Protective Structure (ROPS) and a seat belt.

 **Entanglement hazard**  
Before transporting, make sure the PTO is disengaged and all tine movement has stopped.

#### **SAFETY INSTRUCTIONS**

The following safety instructions are provided to help prevent injury or limit equipment damage.

 **Drive Safely**  
Be a safe and courteous driver. Anticipate what other drivers will do and drive accordingly.

 **Allow Extra Distance**  
Apply brakes early. Leave extra distance between your vehicle and the one(s) ahead to provide adequate stopping space. Extra distance will be required to stop the vehicle.

 **Clear Vision**  
Remove all objects from the area that would prevent clear vision of the complete work area or would present an obstacle when moving the rotary tiller.

 **Hitch Attachment**  
Be sure the rotary tiller is securely attached to the tractor and in good operating condition before using.

 **Working Taillights**  
Make sure lights on the tractor are working properly.

 **Additional Lighting**  
For rotary tillers without lights, install additional lights on the rear of the tractor to safeguard against rear-end collisions. Daybreak and dusk are particularly dangerous and rear pilot vehicles are recommended. Rotary tillers without lights should be transported on public roads only during daylight hours.

 **Hazard Flashers**  
Use hazard flashers on the tractor when transporting unless prohibited by law.

 **Right-of-Way**  
When travelling below the posted speed limit, keep to the right and yield the right-of-way to allow faster traffic to pass.

## 8. Storage

---

### 8.1 Storage Safety

At the end of the season, the rotary tiller should be thoroughly inspected and prepared for storage. Repair or replace any worn or damaged components to prevent any unnecessary downtime at the beginning of the next season.

#### CAUTION



Personal Injury Hazard

**Store the rotary tiller in an area away from human activity. To prevent the possibility of serious injury, do not permit children to play on or around the stored rotary tiller.**

---



Crush Hazard

**Always set the rotary tiller on the parking stand or on blocks for storage.**

---

#### NOTICE

*To prevent damage to the rotary tiller, store it in a dry, level area.*

---

### 8.2 Placing in Storage

1. Remove all entangled vegetation.
2. Thoroughly wash the rotary tiller with a pressure washer or water hose to remove all dirt, mud, or debris.
3. Select an area that is dry, level, and free of debris (inside a building is ideal). Move the rotary tiller to its storage area.
4. Lower the tiller to the ground or onto blocks.
5. Disconnect the tiller drive line and secure it up off the ground.
6. Disconnect the rotary tiller from the 3-point hitch and drive the tractor away from the rotary tiller. Do not leave the tractor attached to the rotary tiller.
7. Lubricate all grease points. Make sure all grease cavities have been filled with grease to remove any water residue from washing.
8. Touch up all paint nicks and scratches to prevent rusting.

### 8.3 Removing from Storage

When removing the rotary tiller from storage, follow this procedure:

1. Attach the rotary tiller to the tractor 3-point hitch.
2. Raise the rotary tiller up off the blocks.
3. Before placing the rotary tiller back into service, replace any worn or defective parts and perform the Pre-Operation Checklist.



## 9. Service and Maintenance

### 9.1 Maintenance Safety

#### **WARNING**

Failure to comply with the following safety instructions can and will result in serious injury and possibly even death.



Personal  
Protection  
Equipment

Wear close fitting and belted clothing to avoid getting caught in moving parts. Wear personal protection equipment (PPE), which may include hard hat, safety glasses, safety shoes, gloves, etc. appropriate for the work site and working conditions.



**Disconnect Driveline**

To prevent injury due to possible unexpected movement, disconnect the driveline from the tractor PTO before performing any maintenance procedure.



**Damaged Parts Hazard**

Do not use the rotary tiller if any parts are damaged. If the rotary tiller is believed to have a defect which could cause it to work improperly, immediately stop using it and remedy the problem before continuing.



**No Unauthorized Modifications**

Do not modify the rotary tiller or safety devices. Do not weld on the unit.

Unauthorized modifications may impair its function and safety and will void the warranty.

If the rotary tiller has been altered in any way from the original design, the manufacturer does not accept any liability for injury or warranty.



**Crush Hazard**

Always set the rotary tiller on safety stands or on the ground when performing maintenance.



**Good Working Condition**

Keep all parts in good condition and properly installed. Fix damage immediately. Replace worn or broken parts.



**Replacement Parts**

If replacement parts are necessary, genuine factory replacement parts must be used to restore the unit to its original specifications. The manufacturer will not accept responsibility for damages as a result of the use of unapproved parts.

#### **WARNING**



**Safety Shields and Devices**

When completing a maintenance or service function, make sure all safety shields and devices are installed before placing the rotary tiller in service.

#### **SAFETY INSTRUCTIONS**

The following safety instructions are provided to help prevent injury or limit equipment damage.



**Safety Equipment**

A fire extinguisher and first aid kit should be readily accessible while performing maintenance on this equipment.



**Clean Work Area**

Do not leave tools lying around the work area. Follow good shop practices. Keep service area clean and dry. Be sure electrical outlets and tools are properly grounded. Use adequate light.



**Use the Right Tools**

Use the correct tools, jacks, hoists, or other tools that have the capacity for the job.



**Proper Support**

Use support blocks when working beneath the rotary tiller, or performing repairs, service, or maintenance.

Make sure the blocks are stable and the rotary tiller frame is approximately level. Test the stability of the rotary tiller before working underneath.

If the rotary tiller is attached to the tractor, set the brakes, remove the key, chock the tractor wheels, and block the rotary tiller before working underneath.

Tighten the lower 3-point arm anti-sway mechanism to prevent side-to-side movement.

## 9.2 Greasing

Grease zerks are located on the driveline U-joint cardan crosses, and the rotor shaft hub.



Grease all zerks every eight hours of operation. Use an SAE multipurpose high-temperature grease with extreme pressure (EP) performance. Also acceptable is an SAE multipurpose lithium base grease.

1. Always use a handheld grease gun for all greasing.
2. Wipe grease zerks with a clean cloth before greasing to avoid injecting dirt and grit.
3. Apply grease until new grease can be seen coming out of the joint.
4. Do not let excess grease collect on or around parts, particularly when operating in sandy areas.
5. Replace and repair broken grease zerks immediately.
6. If any grease zerk will not take grease, remove and clean it thoroughly. Also clean the lubricant passageway. Replace the zerk if necessary.

## 9.3 Gearbox Lubrication

The gearbox is filled at the factory and should require no maintenance. If there is evidence of leakage, the grease level should be checked. If required, grease should be added until it comes to the proper level. Recommended lubricant is EP-0 Grease. Total capacity is 47 ounces.

**Note:** Make sure the rotary tiller is level when checking the oil in the gearbox.

**Note:** Overfilling the gearbox will cause pressure to build up and cause the seals to leak.

## 9.4 Side Gearcase Lubrication

The gearcase is filled at the factory and should require no maintenance. If there is evidence of leakage, the grease level should be checked. If required, grease should be added to the proper level. Recommended lubricant is EP-0 Grease. Total capacity is 70 ounces.

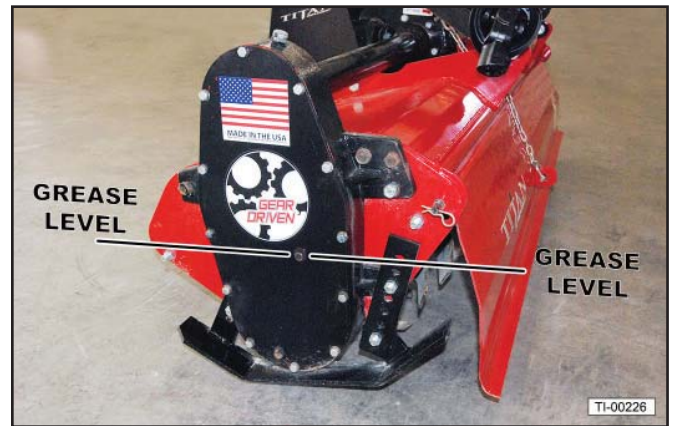

**Note:** Make sure the rotary tiller is level when checking the oil in the gearcase.

**Note:** Overfilling the gearcase will cause pressure to build up and cause the seals to leak.

## 9.5 Driveline Lubrication

Lubricate the driveline slip joint every fifty operating hours.

1. Lower the rotary tiller to the ground, disconnect the driveline from the tractor PTO shaft, and slide the halves apart but do not disconnect from each other.
2. Apply a bead of grease completely around the male half where it meets the female half. Slide drive halves over each other several times to distribute grease.

## 9.6 Lifting

To lift the rotary tiller, attach the lifting device to the lifting point provided.

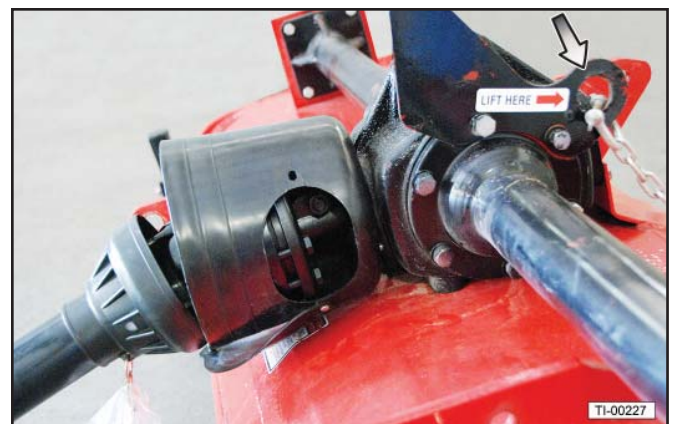

## 9.7 Tine Replacement

Visually inspect the tines before each use to determine that they are properly installed and in good condition. Replace any tine that is bent, excessively nicked, worn, or has any other damage.

Manually wiggle the tines to check for any looseness. Recheck torque every fifty hours. Retighten any loose tines.

To remove a tine, remove the two bolts and nuts that attach the tine to the rotor assembly.



When installing tines, be sure they are installed with the cutting edge in the correct orientation. Install the bolts with the heads against the tine and the nuts against the mounting flange. Tighten the nuts to 120 ft.lbs.

Always use new OEM bolts and nuts when replacing a tine.

## 9.8 Slip Clutch Adjustment

The slip clutch is factory preset to the correct torque for protecting the implement and tractor. Periodic adjustment is recommended. Should adjustment be needed, follow this procedure:

1. Check to be sure all spring lengths are the same. Initial spring length is shown in the chart.

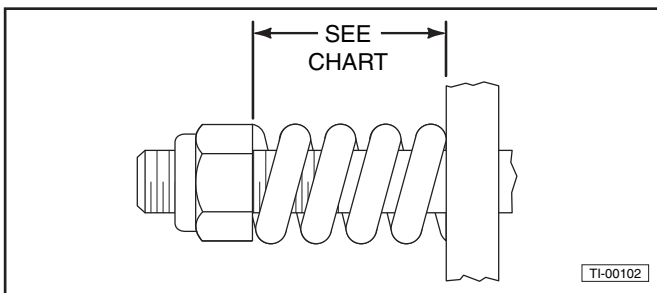

CLUTCH SPRING LENGTH CHART	
EG / COMER	BONDIOLI & PAVESI
1.27" (32.2mm)	1.15" (29.3mm)
1.28" (32.4mm)	1.12" (28.5mm)

2. If necessary, adjust the nut on any spring that is unequal. Adjust all eight spring retaining nuts 1/3 of a turn (two flats on a nut) and check clutch slippage.
3. If further adjustment is necessary, adjust in 1/3 turn increments. Adjust only to provide sufficient torque to prevent slippage under normal conditions. Occasional slippage is normal for drive train protection. If satisfactory results cannot be obtained, consult your authorized dealer.

## NOTICE

*Do not overtighten and cause the spring to become solid, as this will cause shaft failure.*

## 9.9 Slip Clutch Operational Check

If the slip clutch has been exposed to weather for an extended period of time, the clutch facing and plates should be inspected for rust and/or corrosion, which may inhibit function. After the rotary tiller has been stored for thirty days or more, perform the following check:

1. Mark a pencil line across the edges of the clutch plates and friction discs.
2. Loosen the eight nuts holding the clutch springs exactly two full turns. Hold the bolt so that it does not turn.

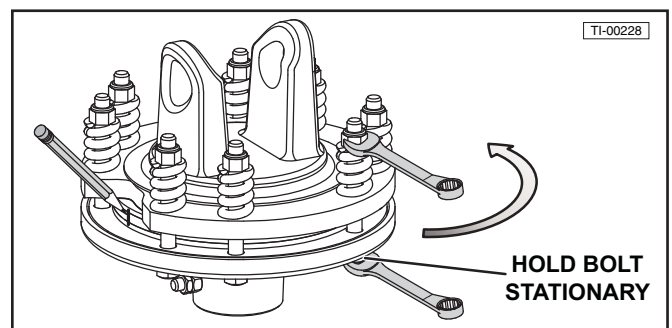

3. Start the tractor and engage the tractor PTO drive for 2-3 seconds. Disengage the PTO, then re-engage for an additional 2-3 seconds. The clutch should slip without turning the tines. Disengage the PTO, shut down the engine, remove the key, and wait for all motion to come to a complete stop before exiting the tractor.
4. Verify that the pencil lines have changed position. If the marks are still aligned, the clutch did not slip. If the clutch did not slip, it will need to be disassembled to separate the clutch plates from the friction discs. Refer to "9.10 Slip Clutch Disassembly/Assembly" on page 36.
5. Retighten the eight nuts to their original position.

## NOTICE

*Incorrect slip clutch torque settings may cause damage to the tiller and/or tractor. Be sure to retighten the nuts to their original position.*

**Note:** Check the clutch periodically during the first hour of operation for excessive heat build-up due to unexpected slippage.

### 9.10 Slip Clutch Disassembly/Assembly

If the clutch did not slip during the operational check, it will need to be disassembled to separate the clutch plates from the friction discs.

1. Measure and record the compressed (assembled) spring length. This dimension will be needed for reassembly.
2. Remove spring retainer nuts (1), springs (2), and bolts (3).

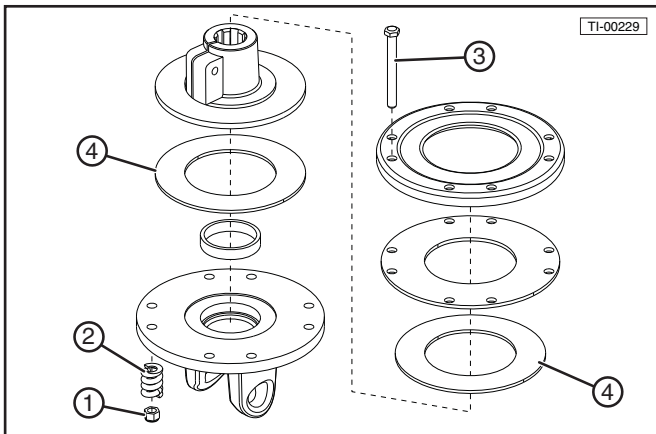

3. Separate each friction disc (4) from the clutch plate next to it. **Keep the parts in order, so that they can be reassembled in the same order.**
4. Clean and inspect all parts. If the clutch has been slipped to the point of “smoking”, the friction discs should be replaced.
5. Reassemble each friction disc (4) next to the same clutch plate it was removed from. Make certain all bushings are replaced in the same location they were removed from. Install bolts (3) through the end plates and intermediate plates as shown. Place springs (2) over each bolt and secure with nuts (1).
6. Tighten each nut until the original spring length is attained. If the original length was not recorded, use the spring length from the chart in “9.8 Slip Clutch Adjustment” on page 35.

### 9.11 Bolt Torque Requirements

It is extremely important to apply and maintain proper torque on all bolts. Use a torque wrench to assure the proper amount of torque is being applied to the fastener. For proper bolt torque values, refer to “11.1 Bolt Torque” on page 40.

Start all bolts or nuts by hand to prevent cross threading.

## NOTICE

*The tiller frame end plates are welded and bolted in place. Do not remove these bolts. They are a necessary part of the structural design.*



### 9.12 Welding Repairs



Before performing any type of welding repair to the rotary tiller, contact Titan Implement for approval. Repair welding must be done with care and with procedures that may be beyond the capabilities of the ordinary welder.

## WARNING



**Projectile Hazard**  
**Do not attempt to weld on the blades. They are hardened and will crack or otherwise be damaged, causing failure and possible serious injury or death from thrown blades.**



**Personal Injury Hazard**  
**Repairs or modifications to the rotary tiller can result in serious injury or death should these repairs fail.**

## NOTICE

*Anyone performing a welding repair should be certified in accordance to the American Welding Society (AWS) standards.*

### 9.13 Service Record

The period recommended is based on normal operating conditions. Severe or unusual conditions may require more frequent lubrication or oil changes.

Copy this page to continue record.

Hours and Serviced By															
<b>Maintenance</b>															
<b>Before Each Use</b>															
Check the gearbox and side gearcase for evidence of leakage.															
Make sure the driveline is securely attached and undamaged.															
Make sure all retainer clips and cotter pins are in place.															
Inspect the tines for wear and damage.															
<b>Every 50 Hours*</b>															
Grease all lubrication points. Refer to "9.2 Greasing" on page 34.															
Lubricate the Driveline. Refer to "9.5 Driveline Lubrication" on page 34.															
Check gearbox and gear drive case oil level.															
*Or annually, if used less than 50 hours per year.															
<b>Annually</b>															
Grease all lubrication points. Refer to "9.2 Greasing" on page 34.															
Make sure all fasteners are properly tightened.															
Check tiller frame, gearbox, and driveline for damage.															
Inspect the tines for wear and damage.															
Make sure the 3-point hitch pins and retainer clips are in good condition. Do not use homemade or shop-made pins.															
Make sure the slip clutch is functioning properly. Refer to "9.9 Slip Clutch Operational Check" on page 35.															
Inspect the hitch A-frame and braces for wear and damage.															
Wash the rotary tiller.															

## 10. Troubleshooting

PROBLEM	CAUSE	SOLUTION
Uneven till.	Tiller not level side-to-side.	Adjust skid shoes to the same depth. Refer to "6.7 Setting the Tilling Depth" on page 27.
		Adjust tractor lower lift arms.
Bogging.	Tractor engine speed too slow.	Maintain 540 RPM PTO speed.
	Excessive ground speed.	Reduce ground speed. Refer to "6.12 Tiller Operation" on page 30.
	Material wrapped around rotor.	Remove entangled material.
Tillage depth insufficient.	Tiller being carried by tractor..	Lower tractor lift arms.
	Tractor has insufficient power	Increase engine RPM. Maintain 540 RPM PTO speed.
	Skid shoes not properly adjusted.	Adjust skid shoes.
	Tines worn or bent	Replace worn or damaged tines.
	Tines are installed incorrectly	Check tine orientation.
	Material wrapped around rotor.	Remove entangled material.
Unusual noise.	Tines are loose.	Tighten tines.
Rotary tiller skips or leaves residue.	Slip clutch slipping.	Adjust slip clutch. Refer to "9.8 Slip Clutch Adjustment" on page 35.
	Tines are badly worn.	Replace worn tines..
	Excessive ground speed.	Reduce ground speed.
Rotor will not turn.	PTO not engaged.	Engage PTO
	Slip clutch slipping.	Adjust slip clutch. Refer to "9.8 Slip Clutch Adjustment" on page 35.
Tillage too coarse.	PTO RPM is too low.	Maintain 540 RPM PTO speed.
	Excessive ground speed.	Reduce ground speed.
Tillage too fine.	Insufficient ground speed.	Increase ground speed.
Gearbox noisy.	Low lubricant level.	Add grease. Refer to "9.3 Gearbox Lubrication" on page 34.
	Worn bearing.	Replace bearing.
Gearbox leaking.	Damaged oil seal.	Replace seal.
	Bent shaft.	Replace gearbox.
	Oil level too high.	Drain to proper level.
	Gasket damaged.	Replace gasket.
	Bolts loose.	Tighten bolts.
Gearbox overheating.	Low on lubricant.	Fill to level plug.
	Improper type of lubricant.	Replace with proper lubricant. Refer to "9.3 Gearbox Lubrication" on page 34.
Excessive vibration.	Universal joint worn.	Replace universal joint.
	Tiller is lifted too high.	Lower tiller and readjust 3-point lift stop.
Driveline will not telescope.	Improper lubrication.	Grease driveline. Refer to "9.5 Driveline Lubrication" on page 34.
	Driveline bent.	Driveline too long. Replace and shorten to proper length. Refer to "5.5 Shortening the Driveline" on page 23.
	Shields damaged.	Replace shields.
Driveline twisted.	Not maintaining correct PTO speed.	Maintain 540 RPM PTO speed.
Tines balling up with soil.	Tines worn or bent.	Replace worn or damaged tines.
	Tines are installed incorrectly.	Check tine orientation.
	Excessive ground speed.	Reduce ground speed.
	Soil conditions too wet.	Wait until soil dries.
Increased wear on tines directly behind tractor tires.	Tractor tires compacting soil, causing increased wear on tines.	Replace worn tines.

## 11. Specifications

Model	2104	2105	2106	2107
<b>Horsepower Required (Min.)</b>	20-35	20-40	30-50	45-65
<b>Hitch</b>	CAT I	CAT I	CAT I	CAT I or II
<b>Tillage Width</b>	48"	60"	72"	84"
<b>Weight (lbs.)</b>	600	690	780	865
<b>Drive Type</b>	Heavy Duty Gear Drive	Heavy Duty Gear Drive	Heavy Duty Gear Drive	Heavy Duty Gear Drive
<b>No. of Flanges</b>	6	7	9	11
<b>No. of Tines</b>	36	42	54	66
<b>Skid Shoes</b>	Adjustable	Adjustable	Adjustable	Adjustable
<b>PTO Driveshaft</b>	Heavy Duty with Slip Clutch	Heavy Duty with Slip Clutch	Heavy Duty with Slip Clutch	Heavy Duty with Slip Clutch
<b>Deflector</b>	Rear Hinged	Rear Hinged	Rear Hinged	Rear Hinged
<b>Quick Hitch Compatible</b>	Yes, CAT I	Yes, CAT I	Yes, CAT I	Yes, CAT I/II
<b>Gearbox Warranty</b>	1 Year Limited	1 Year Limited	1 Year Limited	1 Year Limited





Specifications subject to change without notice.

## 11.1 Bolt Torque

Torque figures indicated in the charts are used for non-greased or non-oiled threads and heads unless otherwise specified. Therefore, do not grease or oil bolts or cap screws unless otherwise specified in this manual. When using locking elements, increase torque values by 5%.

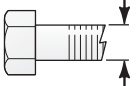
The tables shown below give correct torque values for various bolts and capscrews. Tighten all bolts to the torques specified in the charts unless otherwise noted. Check tightness of bolts periodically, using the bolt torque chart as a guide. Always replace hardware with the same Grade bolt.

### 11.1.1 Standard Torque Values

 Bolt Diameter	English Bolt Torque Specifications*					
	Grade 2		Grade 5		Grade 8	
	 No Marking		 3 Radial Lines		 6 Radial Lines	
	N·m	ft.lbs.	N·m	ft.lbs.	N·m	ft.lbs.
1/4"	8	6	12	9	17	12
5/16"	13	10	25	19	36	27
3/8"	27	20	45	33	63	45
7/16"	41	30	72	53	100	75
1/2"	61	45	110	80	155	115
9/16"	95	60	155	115	220	165
5/8"	128	95	215	158	305	220
3/4"	225	165	390	290	540	398
7/8"	230	170	570	420	880	650
1"	345	225	850	630	1320	970



## 12. Warranty

---

### TITAN IMPLEMENT LIMITED WARRANTY

TITAN IMPLEMENT, LLC. (the “Manufacturer”) warrants, only to the original Purchaser, this equipment will be free from defects in material and workmanship, under normal use and service, for one (1) year from the date of purchase providing this equipment is purchased for individual use only. **Commercial use of this equipment is not covered under any warranty.** This warranty does not apply to any equipment which has been damaged or which has been subjected to change, misuse, negligence, abnormal wear and tear, alterations, tampering, or failure to follow operating instructions. This warranty does not cover any product or parts not manufactured by Titan Implement, LLC.

**Titan Implement, LLC rotary tillers have a one (1) year Limited Warranty\* on gearbox components provided they have been properly maintained\*\* and have not been subjected to abuse or misuse except as limited below.**

#### **\*Gearbox warranty limitations:**

- i. Warranty is one (1) year for seals unless seals are damaged from debris wrapped around the input and or output shaft of the gearbox. After one year, seals are considered to be wearing parts, and the replacement is the owner’s responsibility.
- ii. Gearboxes that are subject to warranty may be replaced with new or rebuilt gearboxes at the discretion of Titan Implement, LLC.

#### **\*\*NOTE: “properly maintained” specifically includes, but is not limited to:**

- i. Running gearboxes with the proper amount of correct lubricant.
- ii. Adjusting slip clutches correctly to provide proper protection for gearbox components and drive line.

Under this warranty, the Manufacturer will repair or replace any part which the Manufacturer determines has failed during the period of the warranty due to defects in material or workmanship. After written approval by the manufacturer, the equipment or defective part must be returned to Titan Implement, LLC.

Warranty coverage and performance is expressly conditioned upon the return of the completed registration form to Titan Implement, LLC, PO Box 649, Decatur, Tennessee 37322.

Titan Implement, LLC reserves the right to make improvements and changes in specifications without notice or obligation to modify previously sold units. The Owner’s Manual describes the proper assembly procedures for your implement and furnishes operating and maintenance recommendations to help you obtain long and satisfactory service.

**PURCHASER’S EXCLUSIVE REMEDY FOR BREACH OF WARRANTY, OTHER DEFECT, OR CONDUCT GIVING RISE TO LIABILITY SHALL BE THE REPAIR OR REPLACEMENT OF THE PRODUCT SOLD, AND THE MANUFACTURER UNDER NO CIRCUMSTANCES SHALL BE LIABLE FOR ECONOMIC LOSS OR INCIDENTAL OR CONSEQUENTIAL DAMAGES. THE MANUFACTURER DISCLAIMS ALL IMPLIED WARRANTIES, INCLUDING THE WARRANTY OF MERCHANTABILITY AND FITNESS FOR PURPOSE.**

Purchaser and Titan Implement, LLC hereby (a) submit to the non-exclusive jurisdiction of the courts of competent jurisdiction in Meigs County, Tennessee, and the United State District Court for the Eastern District of Tennessee for resolution of any dispute concerning this Limited Warranty or the rights or obligations of Purchaser and/or Titan Implement, LLC; (b) agree that any litigation commenced in Tennessee in connection with this Limited Warranty shall be venued in either the Meigs Count, Tennessee District Court, or the United States District Court, Eastern District of Tennessee, Southern Division, and (c) waive any objection it may have as to any such action or proceeding brought in such court that such court is an inconvenient forum. Nothing herein shall limit the right of Purchaser or Titan Implement, LLC (or the right of any permitted successor or assign of either) to bring proceedings against the other in the courts of any other jurisdiction wherein any assets of such other party may be located.



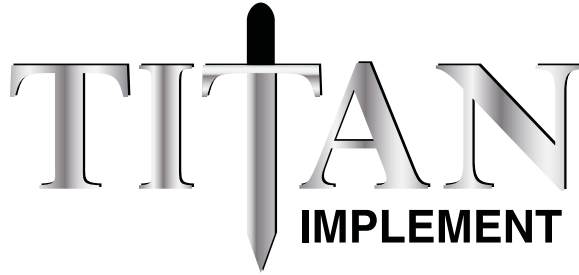

## WARRANTY REGISTRATION FORM ROTARY TILLERS

THIS REGISTRATION FORM MUST BE ON FILE WITH TITAN IMPLEMENT, LLC.  
WITHIN **30 DAYS** OF DELIVERY TO PURCHASER, OR WARRANTY CLAIM WILL NOT BE HONORED.

PLEASE RETURN COMPLETED FORM BY E-MAIL, FAX, OR MAIL:

E-MAIL: INFO@TITANIMPLEMENT.COM

FAX: (423) 334-0023

MAIL: PO BOX 649, DECATUR, TN 37322

MODEL: \_\_\_\_\_ SERIAL #: \_\_\_\_\_ DELIVERY DATE: \_\_\_\_\_

TRACTOR MAKE & MODEL BEING USED WITH ABOVE UNIT: \_\_\_\_\_

PURCHASER'S NAME: \_\_\_\_\_

ADDRESS: \_\_\_\_\_

CITY: \_\_\_\_\_ STATE: \_\_\_\_\_ ZIP: \_\_\_\_\_

SELLING DEALER'S NAME: \_\_\_\_\_

CITY: \_\_\_\_\_ STATE: \_\_\_\_\_ ZIP: \_\_\_\_\_

**I have read all warranties and agree with these conditions. I agree to read and follow all safety instructions outlined in this manual before operating this rotary tiller.**

Purchaser's signature: \_\_\_\_\_

Cut Here to Remove Page or Make Copies of This Page



## 13. Parts

Replacement parts are available from your authorized Dealer Parts Department or from Titan Implement.

The following pages contain a list of serviceable parts for the Titan Implement Rotary tiller.

### 13.1 Hitch Assembly

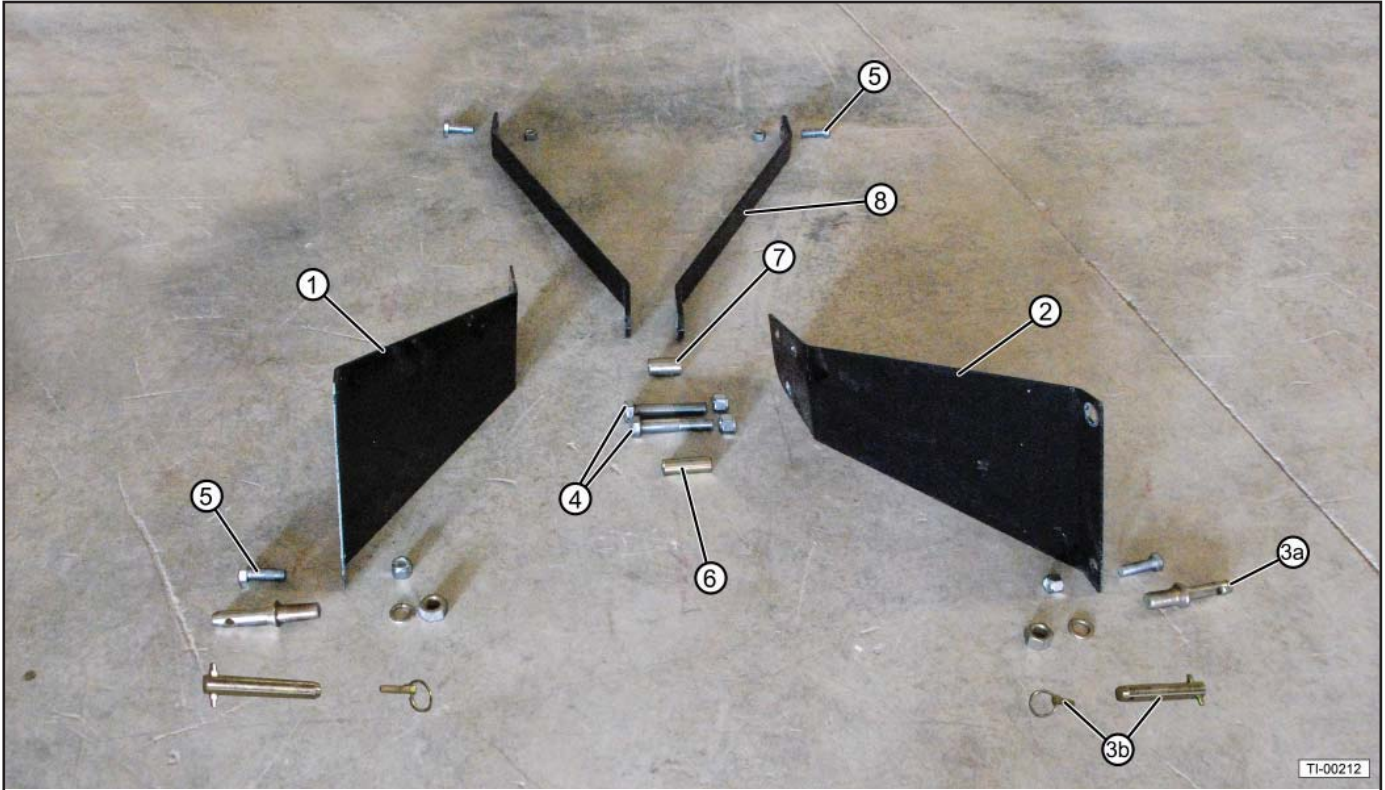

Item	Part Number	Description	Qty.
1	210001	4', 5', 6' A-Frame, Left Side (2104, 2105, 2106)	1
	210005	7' A-Frame, Left Side (2107)	
2	210002	4', 5', 6' A-Frame, Right Side (2104, 2105, 2106)	1
	210006	7' A-Frame, Right Side (2107)	
3a	110032	4', 5', 6' Lift Pin Kit, CAT I (2104, 2105, 2106)	1
3b	450006	7' Stepdown Pin (2107)	

Item	Part Number	Description	Qty.
4	110027	A-Frame Top Bolt & Locknut Kit, 3/4-10 x 4-1/2"	2
5	110015	Back Brace Bolt & Locknut Kit, 5/8-11 x 2"	2
6	110028	A-Frame Spacer, 2-3/4"	1
7	110030	A-Frame / Back Brace Spacer, 2"	1
8	210003	Back Brace, 3/8" x 2" x 32"	2

## 13.2 Frame Assembly

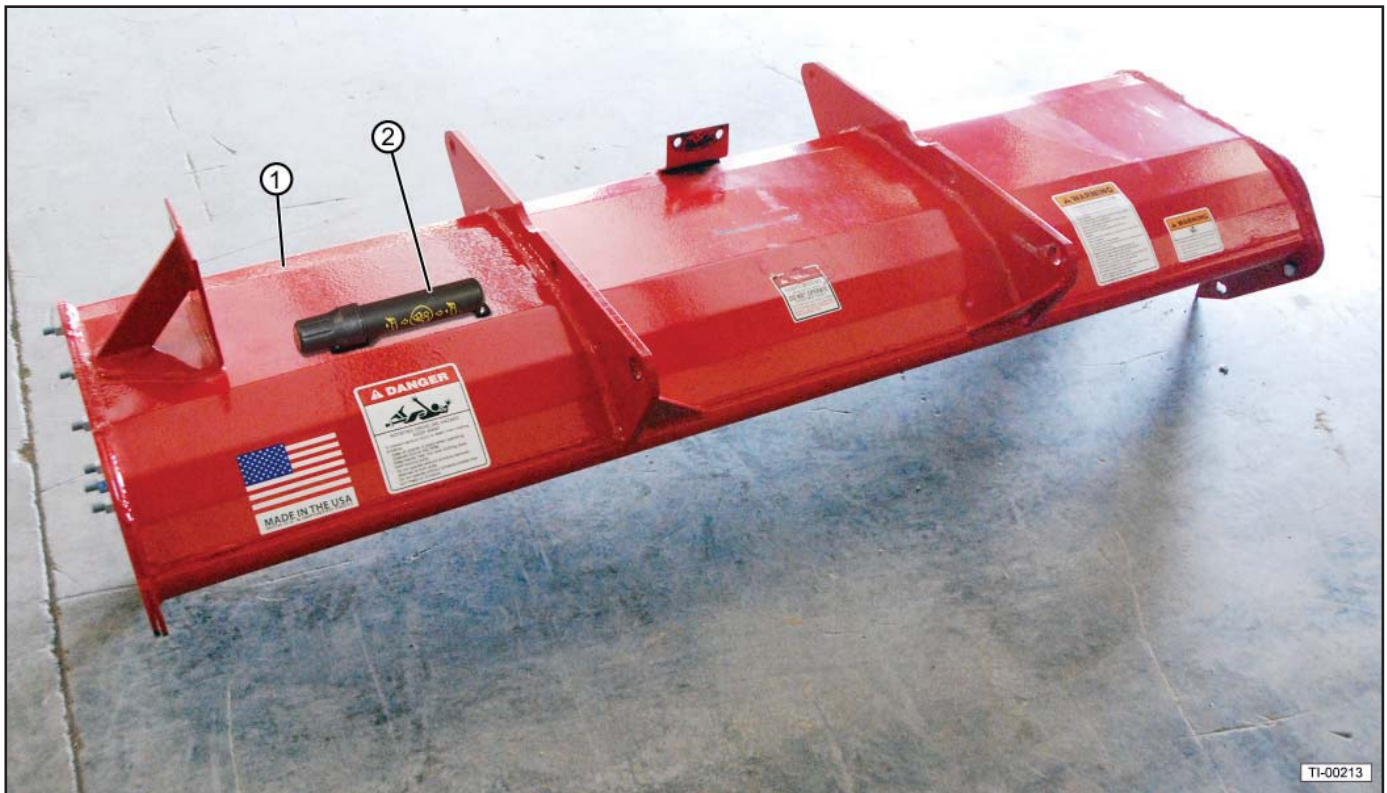

Item	Part Number	Description	Qty.
1	210050	4' Frame Only with Decals - Blue (2104)	1
	210051	4' Frame Only with Decals - Green (2104)	
	210052	4' Frame Only with Decals - Grey (2104)	
	210053	4' Frame Only with Decals - Orange (2104)	
	210054	4' Frame Only with Decals - Red (2104)	
	210055	4' Frame Only with Decals - Yellow (2104)	
1	210056	5' Frame Only with Decals - Blue (2105)	1
	210057	5' Frame Only with Decals - Green (2105)	
	210058	5' Frame Only with Decals - Grey (2105)	
	210059	5' Frame Only with Decals - Orange (2105)	
	210060	5' Frame Only with Decals - Red (2105)	
	210061	5' Frame Only with Decals - Yellow (2105)	

Item	Part Number	Description	Qty.
1	210062	6' Frame Only with Decals - Blue (2106)	1
	210063	6' Frame Only with Decals - Green (2106)	
	210064	6' Frame Only with Decals - Grey (2106)	
	210065	6' Frame Only with Decals - Orange (2106)	
	210066	6' Frame Only with Decals - Red (2106)	
	210067	6' Frame Only with Decals - Yellow (2106)	
1	210068	7' Frame Only with Decals - Blue (2107)	1
	210069	7' Frame Only with Decals - Green (2107)	
	210070	7' Frame Only with Decals - Grey (2107)	
	210071	7' Frame Only with Decals - Orange (2107)	
	210072	7' Frame Only with Decals - Red (2107)	
	210073	7' Frame Only with Decals - Yellow (2107)	
2	110034	Document Holder with Screws	1

### 13.3 Rear Deflector



Item	Part Number	Description	Qty.
1	210074	4' Deflector with Decals - Blue (2104)	1
	210075	4' Deflector with Decals - Green (2104)	
	210076	4' Deflector with Decals - Grey (2104)	
	210077	4' Deflector with Decals - Orange (2104)	
	210078	4' Deflector with Decals - Red (2104)	
	210079	4' Deflector with Decals - Yellow (2104)	
1	210080	5' Deflector with Decals - Blue (2105)	1
	210081	5' Deflector with Decals - Green (2105)	
	210082	5' Deflector with Decals - Grey (2105)	
	210083	5' Deflector with Decals - Orange (2105)	
	210084	5' Deflector with Decals - Red (2105)	
	210085	5' Deflector with Decals - Yellow (2105)	

Item	Part Number	Description	Qty.
1	210086	6' Deflector with Decals - Blue (2106)	1
	210087	6' Deflector with Decals - Green (2106)	
	210088	6' Deflector with Decals - Grey (2106)	
	210089	6' Deflector with Decals - Orange (2106)	
	210090	6' Deflector with Decals - Red (2106)	
	210091	6' Deflector with Decals - Yellow (2106)	
1	210092	7' Deflector with Decals - Blue (2107)	1
	210093	7' Deflector with Decals - Green (2107)	
	210094	7' Deflector with Decals - Grey (2107)	
	210095	7' Deflector with Decals - Orange (2107)	
	210096	7' Deflector with Decals - Red (2107)	
	210097	7' Deflector with Decals - Yellow (2107)	
2	210011 210012 210013 210014	Deflector Gate Rod, 4' (2104) Deflector Gate Rod, 5' (2105) Deflector Gate Rod, 6' (2106) Deflector Gate Rod, 7' (2107)	1
3	210015	Washer, Hinge Rod	1
4	210016	Retainer Clip	1
5	210017	Deflector Gate Chain & Shackle Kit	1

### 13.4 Skid Shoes & Parking Stand

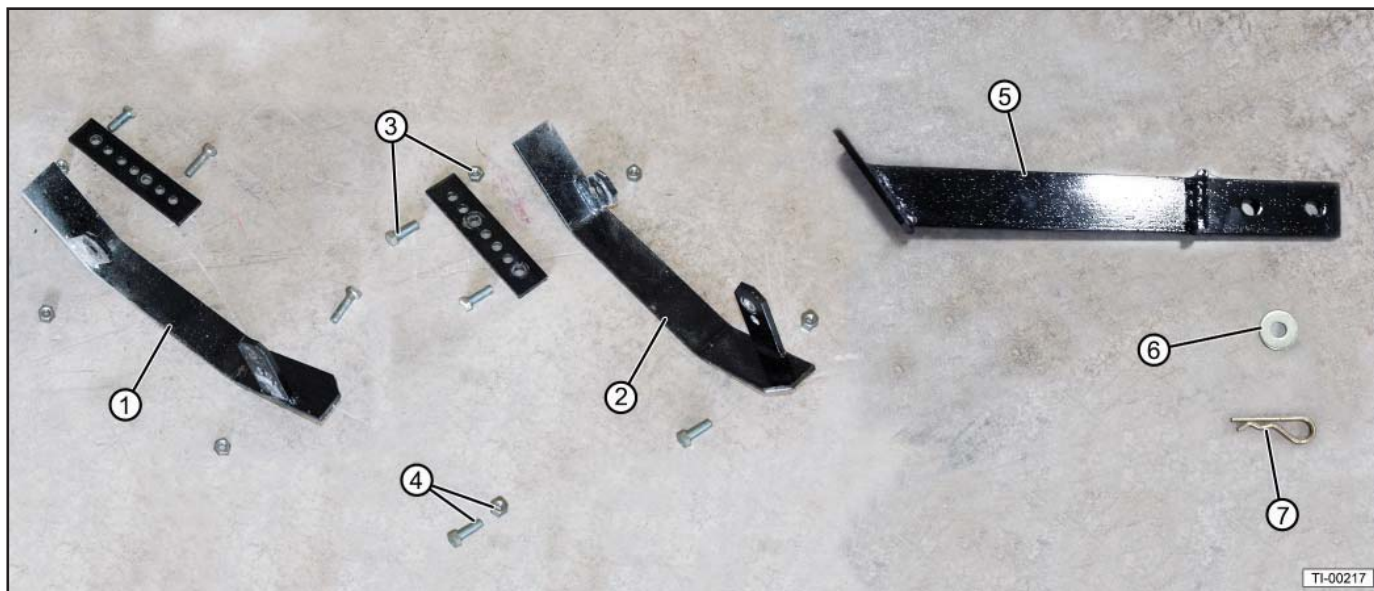

Item	Part Number	Description	Qty.
1	210018	Left Skid Shoe Assembly with Adjuster & Bolt Kit, 1/2-13 x 1-3/4"	1
2	210019	Right Skid Shoe Assembly with Adjuster & Bolt Kit, 1/2-13 x 1-3/4"	1
3	210020	Skid Shoe Bolt Kit, 1/2-13 x 1-3/4"	6
4	210021	Skid Shoe Bolt Kit, 1/2-13 x 2"	5
5	210032	Parking Stand	1
6	210015	Flat Washer, 1/2"	1
7	210016	Hairpin Retainer Clip	1



### 13.5 Rotor Shaft & Tines

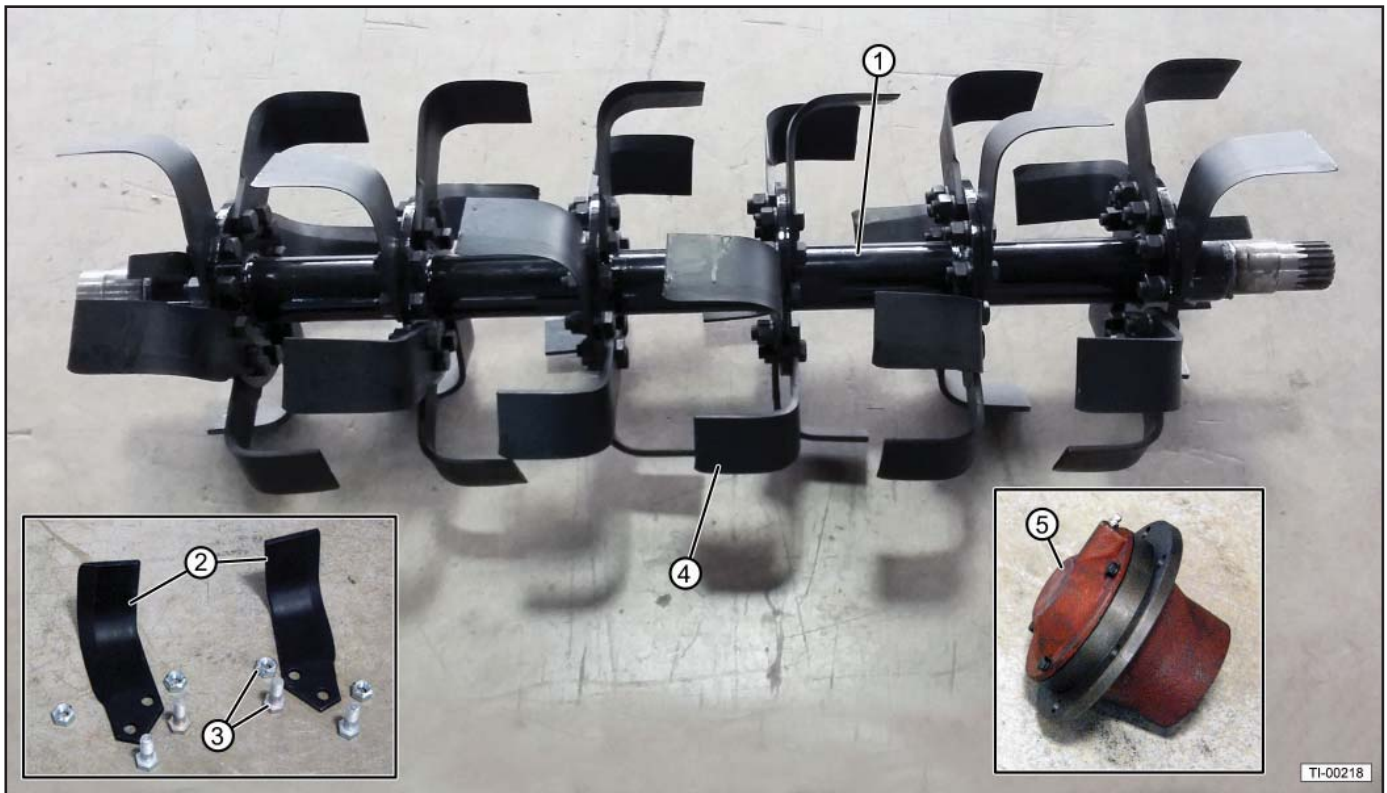

Item	Part Number	Description	Qty.
1	210259	4' Rotor Shaft Assembly w/o Tines (2104)	1
	210260	5' Rotor Shaft Assembly w/o Tines (2105)	
	210261	6' Rotor Shaft Assembly w/o Tines (2106)	
	210262	7' Rotor Shaft Assembly w/o Tines (2107)	
2	210022	Tine Set (1 Left & 1 Right), with Bolt Kit	1
3	210023	Tine Bolt & Nut Kit, 1/2-20 x 1-1/4"	A/R*
4	210024	4' Complete Tine Set, w/ Bolts & Nuts (36 Tines w/ Bolt Kit) (2104)	1
	210025	5' Complete Tine Set, w/ Bolts & Nuts (42 Tines w/ Bolt Kit) (2105)	
	210026	6' Complete Tine Set, w/ Bolts & Nuts (54 Tines w/ Bolt Kit) (2106)	
	210027	7' Complete Tine Set, w/ Bolts & Nuts (66 Tines w/ Bolt Kit) (2107)	
5	210028	Hub Assembly (Left or Right)	2

\*As Required

## 13.6 Driveline Assembly

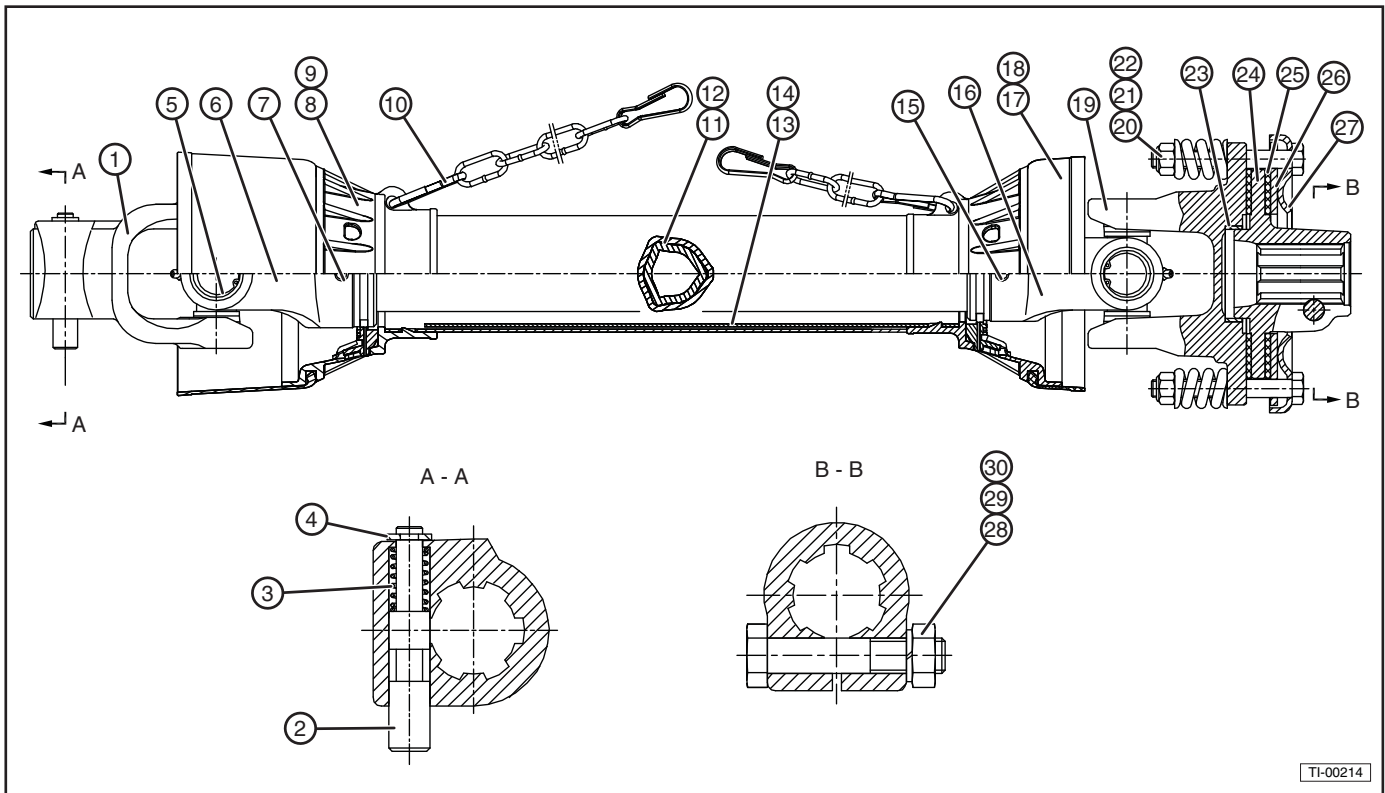

TI-00214

Item	Part Number	Description	Qty.
—	210046	RT-S4-863.5 Driveline, Complete	1
—	120012	PTO 111-724, Fits 5' and 6', Complete Unit	1
Driveline Detail			
1	210301	Splined Yoke	1
2	210302	Push Pin	1
3	210303	Push Pin Spring	1
4	210304	Push Pin Circlip	1
5	210305	Universal Joint	2
6	210306	Outer Triangular Tube Yoke	1
7	210307	Elastic Cylindrical Pin	1
8	210308	Cone for Outer Tube	1
9	210309	Outer Tube Plastic Bearing	1
10	210310	Safety Chains	2
11	210311	Outer Triangular Tube	1
12	210312	Inner Triangular Tube	1
13	210313	Outer Plastic Guard	1
14	210314	Inner Plastic Guard	1

Item	Part Number	Description	Qty.
15	210315	Elastic Cylindrical Pin	1
16	210316	Inner Triangular Tube Yoke	1
17	210317	Cone for Inner Tube with Friction Torque Limiter Cone	1
18	210318	Inner Tube Plastic	1
19	210319	Flanged Yoke	1
20	210320	Hexagon Bolt	8
21	210321	Spring	8
22	210322	Hexagon Non-metallic Clamping Nut	8
23	210323	Bushing	1
24	210324	Hub	1
25	210325	Friction Lining	2
26	210326	Internal Disc	1
27	210327	Pressure Plate	1
28	210328	Fine Tooth Hexagon Bolt	1
29	210329	Fine Tooth Hexagon Nut	1
30	210330	Spring Washer	1

## 13.7 Gearbox

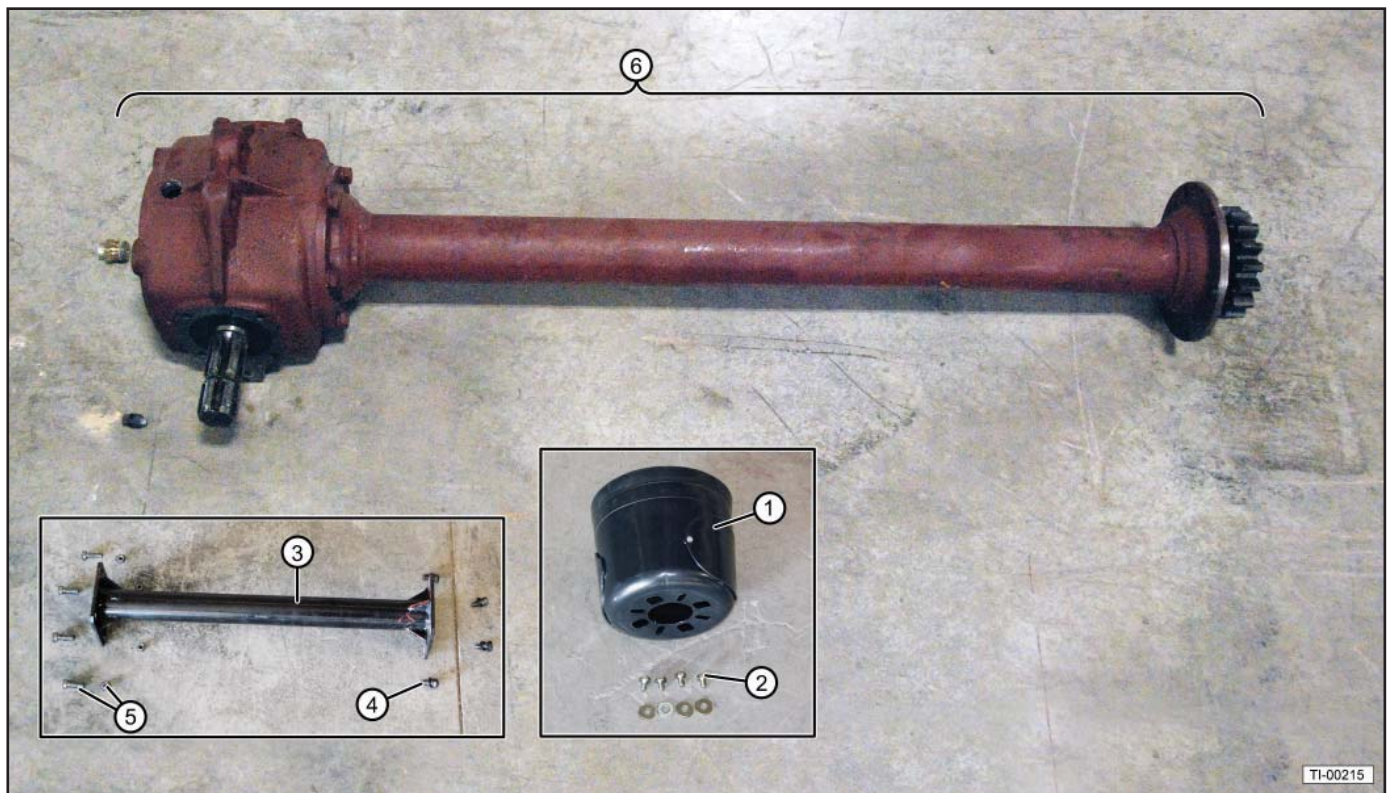

Item	Part Number	Description	Qty.
1	110005	Gearbox Shield (2104, 2105, 2106)	1
	120001	Gearbox Shield, Slip Clutch (2107)	
2	110006	Gearbox Shield Bolt & Washer Kit, 5/16-18 x 1/2" (4 each)	1
3	210251	4' Gearbox Support Tube, Right (2104)	1
	210252	5' Gearbox Support Tube, Right (2105)	
	210253	6' Gearbox Support Tube, Right (2106)	
	210254	7' Gearbox Support Tube, Right (2107)	
4	210007	Tube to Gearbox Bolt & Lock Washer Kit, M10 x 30mm	4
5	510008	Support Tube Bolt & Locknut Kit, 3/8-16 x 1-1/4"	4
6	210040	4' Top Gearbox Assembly (2104)	1
	210041	5' Top Gearbox Assembly (2105)	
	210042	6' Top Gearbox Assembly (2106)	
	210043	7' Top Gearbox Assembly (2107)	

### 13.8 Side Gearcase Detail

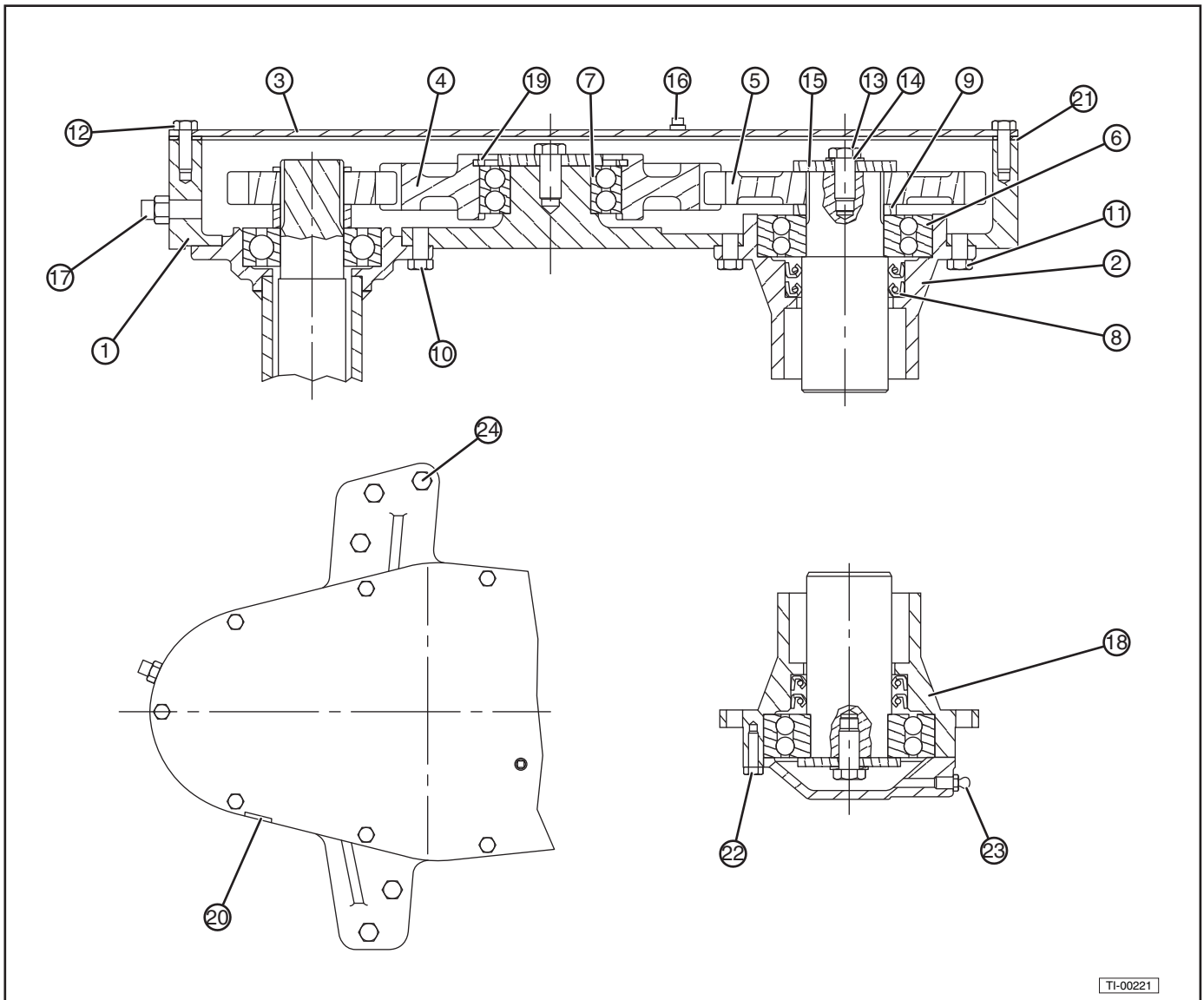

TI-00221

Item	Part Number	Description	Qty.
—	210044	Side Gearcase Assembly, Complete	1
Side Gearcase Detail			
1	210201	Housing, Side Gearcase	1
2	210203	Hub Cap	1
3	210205	Cover, Side Gearcase Housing	1
4	210208	Gear, 34T	1
5	210209	Gear, 28T	1
6	210218	Ball Bearing, Self Aligning, 1310	1
7	210219	Ball Bearing, Double Row, 3210C	1
8	210222	Seal, Double Lip	2
9	210233	Output Spacer	1
10	210236	Hex Cap Screw, M10 x 20mm	6
11	210234	Hex Cap Screw, M10 x 25mm	8
12	210011	Gearcase Side Plate Bolt & Washer Kit, M8 x 16mm	12

Item	Part Number	Description	Qty.
13	210238	Hex Cap Screw, M12 x 25	2
14	210240	Lockwasher, M12, Split Type	2
15	210241	Washer	2
16	210242	Pipe Plug, Square Head, 1/4-18 NPT	1
17	210243	Plug, Pressure Relief, 1/2-14 NPT	1
18	210244	Outboard Hub Subassembly	1
19	210247	Retaining Ring, 90mm	1
20	210249	I.D. Tag	1
21	210250	Cover Gasket, Side Gearcase	1
22	210030	Hub Cap Bolt & Washer Kit, M6 x 16mm	4
23	210031	Zerk Fitting	1
24	210021	Side Gearbox Bolt Kit, 1/2" x 2"	1







**TITAN IMPLEMENT, LLC.**  
**P.O. BOX 649**  
**232 INDUSTRIAL LN.**  
**DECATUR, TENNESSEE 37322**  
**PHONE: (423) 334-0012 • FAX: (423) 334-0023**  
**WEB: [www.titanimplement.com](http://www.titanimplement.com)**

Member of



Titan Implement Website